

EMERGENCY

SELECTION OF EM LIGHTING

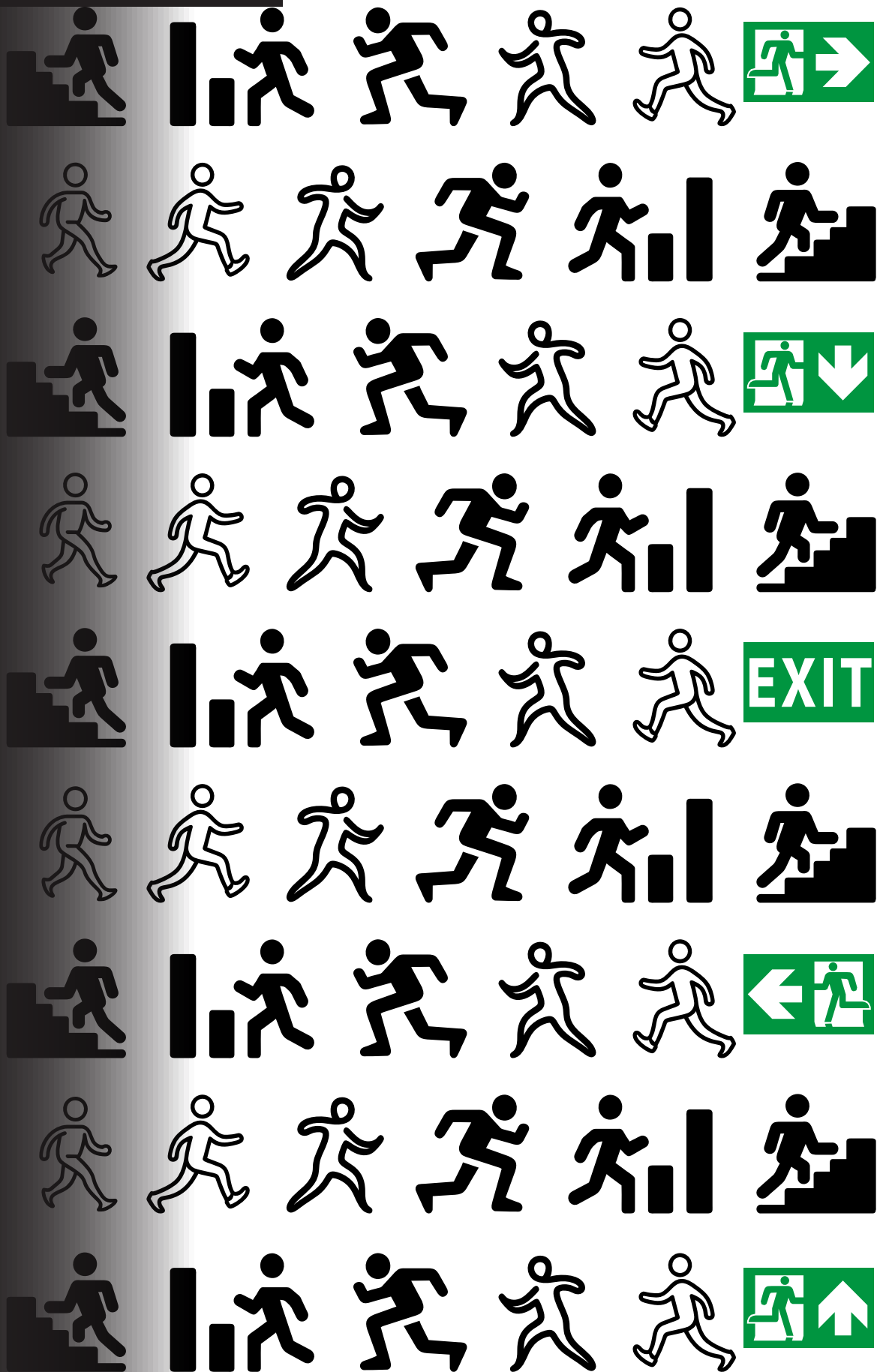

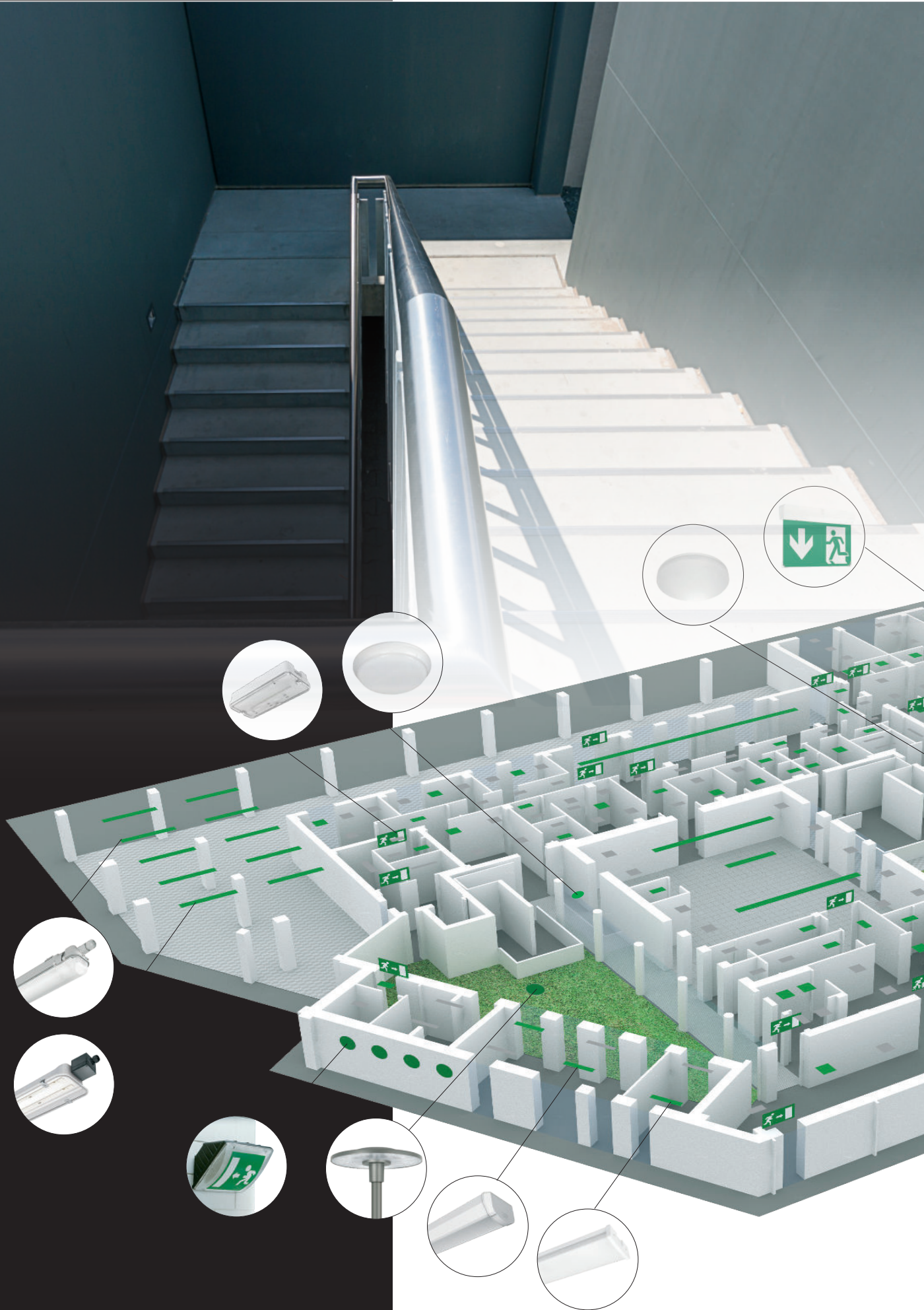

Emergency lighting is an essential safety system to ensure the protection of people during emergency situations. People who are left in the dark during power outages or block-outs, especially in crowded places or during a catastrophic event, will feel uneasy, hence increasing the risk of getting hurt because uneasiness can easily turn into panic. Therefore, an efficient emergency lighting system is an essential requirement to guarantee a safe and fast evacuation during emergencies. If this system is designed in compliance with existing laws and regulations, it will provide the necessary aid that, together with adequate safety signals, will ensure a smooth evacuation from the premises.

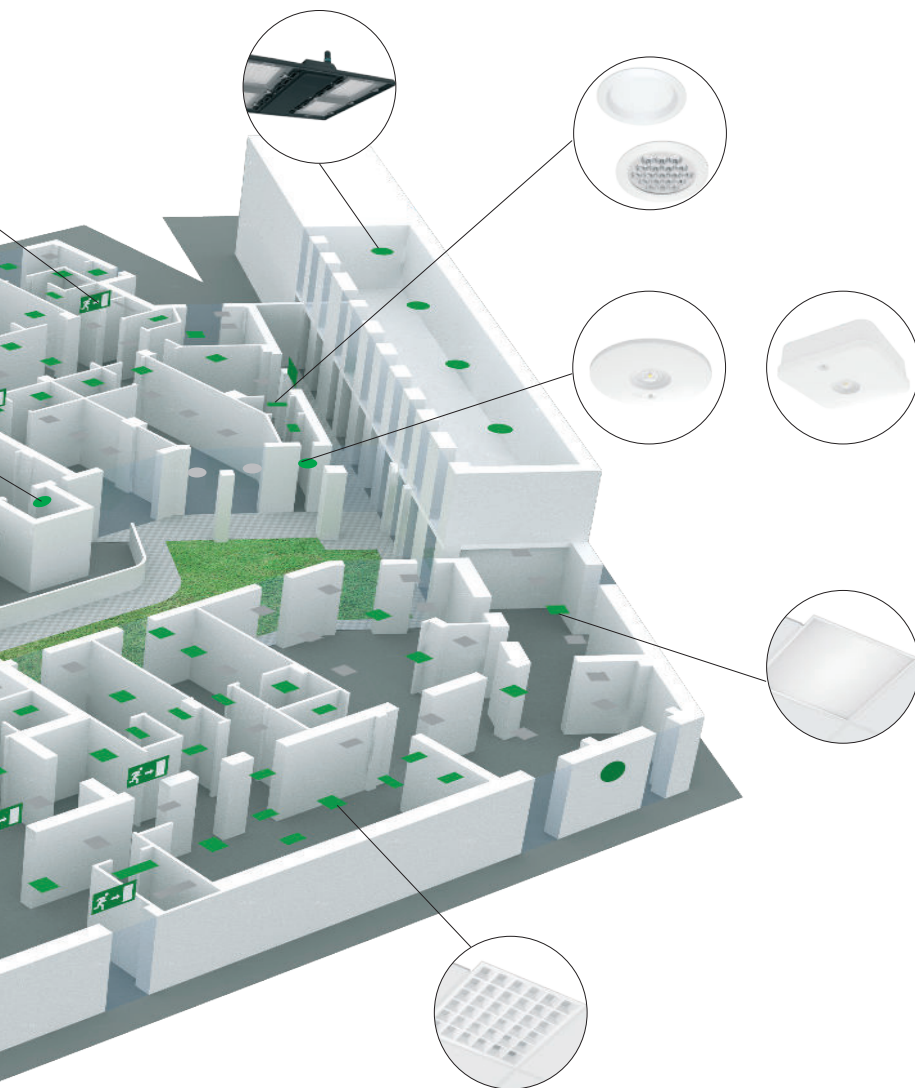

EM S.A. (Maintained): during a blackout, the luminaire connected to the emergency circuit stays on, preventing any inconvenience caused by the sudden loss of lighting. It offers an autonomy of 60/180 minutes. The battery automatically recharges once the power is restored.



EM S.E. (Emergency Only): During of a blackout, the luminaire connected to the emergency circuit will switch on, preventing any inconvenience caused by the sudden loss of lighting. It offers an autonomy of 60/180 minutes. The battery automatically recharges once the power is restored.

EMergency lighting

Back-up lighting

designed for workplaces with potentially hazardous situations. In the event of power outages, it serves as "general lighting" for limited periods of time, so that work activities can be terminated, and premises can be evacuated safely.



Safety lighting

designed to provide minimum light levels to avoid panic and dangerous situations. Escape routes and exit signage must be easily recognisable and visible enough to allow people to escape safely from any location.



Anti-panic lighting

to mitigate panic during a blackout and effectively guide people to safety routes.

Escape route lighting















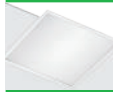





to highlight emergency escape routes and ensure a safe evacuation accurately and clearly.

Safety lighting

for workplaces where potentially work hazards exist (*lights must turn on with a maximum delay of 0.5 seconds, providing at least 10% of the required illuminance for the task being performed or reaching a minimum of 15 lux*)

Info - pictographs

	<p>Fixtures wired with PUSH DALI digital dimmable electronic power supply.</p>		<p>Produced with vandal resistant materials.</p>		<p>Risk Group 0 (RG0): luminaires are exempt from photobiological risks in compliance with standard EN 62471.</p>
	<p>Life expectancy of the LED.</p>		<p>UV-stabilised coating, anti-yellowing. Fixture built with stabilised materials.</p>		<p>Products compliant with ball impact resistance test standard DIN 18032-3: 2018.</p>
	<p>Class II fixture (double insulation). No grounding needed.</p>		<p>Built with materials that are highly resistant to acid and toxic gas corrosion.</p>		<p>WATERPROOF FIXTURES Fixture enclosures are in polycarbonate and keep their IP65/66 waterproof rating if installed, used and maintained in compliance with technical specifications (particularly operating voltage and temperature), as well as with the supplied instructions and applicable standards. Exposure to direct sunlight may heat up the fixture to 45°C compromising the degree of protection. It is advisable to use fixtures properly without altering mechanical properties and protection rating (IP65/IP66); do not install on surfaces subject to strong vibrations, outdoors on hanging cables, or on walls under metallic grates, or on poles, and in any case, never expose the fixture to direct sunlight. Otherwise, use watertight fixtures in steel.</p> <p>Check the compatibility between the material constituting the product and the space where it will be installed</p>
	<p>Fixture surface area exposed to the wind.</p>		<p>Electronic safety device to protect the LED module and the related ballast compliant with EN 61547. It works in two modes: - differential mode: surge between power cables and between the phase and neutral. - common mode: surge between power, L/N and ground cables or between the fixture's body if it is of class II and installed on a metal pole.</p>		
	<p>Minimum and maximum operating temperature. Ask for specific product temperature to our technical offices.</p>		<p>Product with a very low flicker; uniform light for greater eye protection.</p>		
	<p>Size of hole for recessed installation</p>				
	<p>Radial dark light optic unit 65° manufactured according to European EN 12464 Regulations. Suitable for uses in places fitted with video terminals</p>				

		EM S.A.	EM S.E.	+ KIT EM	+BOX EM	-95 ED	-0066 AD	-0050 EM-EC	EM TEST	
	Creta UGR<17			✓		✓	✓	✓		8
	Pannello B DIP SWITCH			✓			✓	✓		10
	PanelTech Rodi DIP SWITCH			✓			✓	✓		12
	PanelTech HE UGR<19			✓		✓	✓	✓		14
				✓		✓	✓	✓		16
	Compact CRI 95 DIP SWITCH			✓			✓	✓		17
	Health Dark UGR<19 DIP SWITCH			✓			✓	✓		18
	Disanlens	✓					✓	✓		20
	Disanlens UGR<19	✓				✓	✓	✓		21
	Oblò J 2.0	✓						✓		22
	Tortuga	✓						✓		23
	Safety 3.0 CCT	✓	✓						✓	24
	Safety 2.0 DIMM	✓	✓							25
	Safety Flag	✓							✓	26
	Safety Round Safety Square		✓						✓	27
	Echo	✓				✓	✓	✓		28
	Forma ATEX							✓		29
	Astro Q UGR<22 UGR<25							✓		30
	Vega	✓								32
	Ischia	✓								33

Safety factor is crucial in designing a good EMergency lighting system

Therefore, any obstacle within two metres above ground level must be illuminated, ensuring there is no risk of bumping or tripping due to insufficient lighting conditions. Emergency lights and signage should be installed at a minimum height of two metres above ground level to ensure visibility even in crowded rooms. In cases where the emergency exit is not immediately visible, an illuminated sign should be installed to indicate the correct direction and evacuation route.

For emergency lighting, we provide four practical and cost-effective solutions to fulfil various needs:



EXAMPLE OF REMOTE CONTROL SYSTEM

NOTE: to order lighting fixtures with an emergency module based on the DALI protocol, use **subcode -95**.

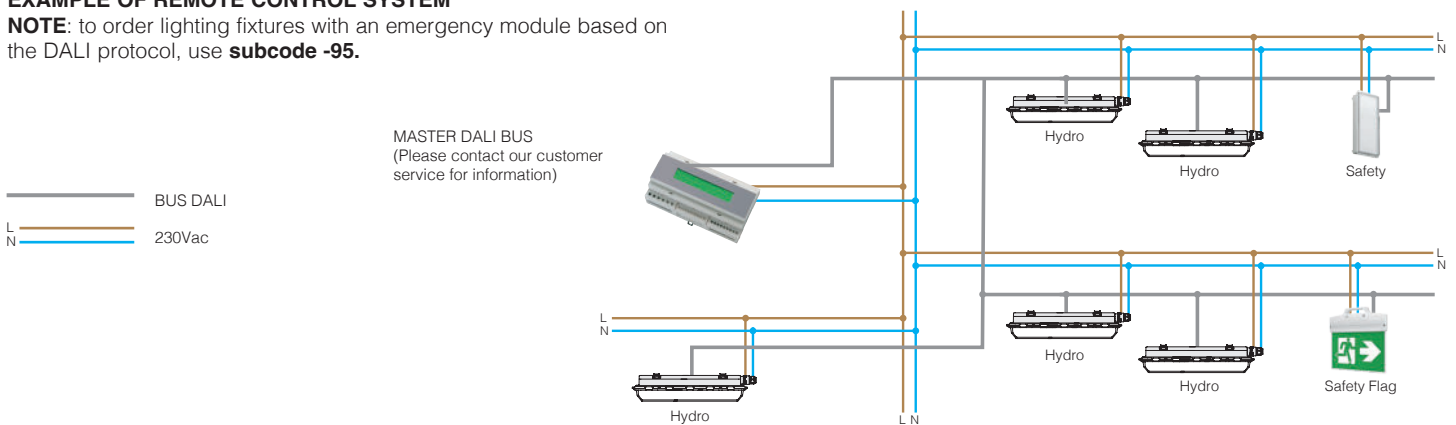

EXAMPLE OF LOCALISED SELF-DIAGNOSTIC LIGHTS

A localised self-diagnostic system uses an integrated module that monitors the operation of the emergency light on each individual lighting fixture. This function is recommended for use in small simple rooms, and an accessory component is to be used on each single fixture.

NOTE: to order lighting fixtures with the self-diagnostic module use **subcode -0066**.

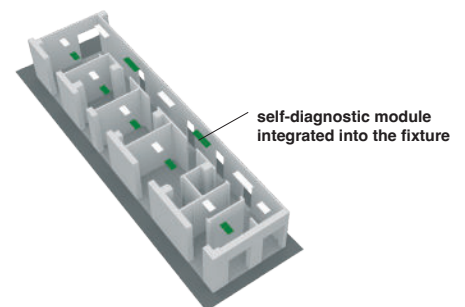

Autonomy

The autonomy of emergency luminaires is governed by IEC standards and guidelines. Emergency luminaires typically ensure continuity for 1 or 1.5 h intervals, depending on their use within the rooms they are installed. While some products declare an autonomy of up to 3 hours or more, the aging of batteries can compromise their ability to meet these declared specifications. In such cases, replacing old batteries becomes necessary. It is recommended to perform a complete battery discharge and recharge cycle at least once every three months to ensure optimal system efficiency.

Recharge

The product standard specifies a charging time of either 12 or 24 hours, which is necessary to recharge the battery and ensure devices maintain their nominal range.

1h = 24h

3h = 24h (or a 12-hour charging period for 1.5 h of autonomy)

EM Basic: S.A. -07



During a blackout, emergency lights ensure practical and safe operation, preventing any inconvenience caused by the sudden loss of lighting. They can be divided in:

- 1) luminaires with built-in emergency module: **subcode -07**
- 2) luminaires with external emergency module, standard version -00 + **acc. 600** emergency kit

- When the battery is charging, the power consumption (W tot) will exceed 3 watts.
- During maintenance (when the battery is charging), the total power (W tot) will exceed a value ranging between 0.5 and 1 Watt.

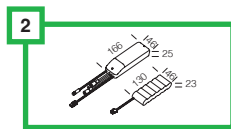
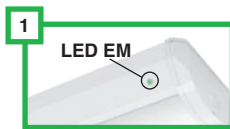

EM Basic: flux percentage (lm) in the EM version only with kit

W tot	1h	3h	W tot	1h	3h	W tot	1h	3h
5	84%	35%	21	20%	8%	37	11%	5%
6	69%	29%	22	19%	8%	38	11%	4%
7	59%	25%	23	18%	7%	39	11%	4%
8	52%	22%	24	17%	7%	40	10%	4%
9	46%	19%	25	16%	7%	41	10%	4%
10	41%	17%	26	16%	7%	42	10%	4%
11	38%	16%	27	15%	6%	43	10%	4%
12	34%	14%	28	15%	6%	44	9%	4%
13	32%	13%	29	14%	6%	45	9%	4%
14	29%	12%	30	14%	6%	46	9%	4%
15	27%	11%	31	13%	6%	47	9%	4%
16	26%	11%	32	13%	5%	48	9%	4%
17	24%	10%	33	12%	5%	49	8%	3%
18	23%	10%	34	12%	5%	50	8%	3%
19	22%	9%	35	12%	5%			
20	21%	9%	36	11%	5%			

When the battery is charging, the power consumption (W tot) will exceed 3 watts. During maintenance (when the battery is charging), the total power (W tot) will exceed a value ranging between 0.5 and 1 Watt.

EM EDali -95



Luminaires with **subcode -95** are available with an emergency system featuring the standard DALI protocol (inverter only), compliant with EN 62386-202 and compatible with all advanced centralised control systems. The biggest advantage of using the DALI protocol in emergency lighting lies in its capability to control both general and emergency lights using a single busbar. This simplifies both the wiring of the system (busbar) and the programming of the entire lighting installation.

NOTE: the -95 equipped product will remain ON-OFF and not DALI dimmable (order with subcode 9541).

ADVANTAGES:

- control of the status of the lighting source (lamp or LED module)
- control of the emergency battery
- functional and/or autonomy tests conducted on the luminaire, groups of luminaires, or the entire system
- control of the light intensity on Only EMergency (SE) and Always On (SA)

EM Self-Diagnosis -0066



Most emergency ceiling lights can be equipped with a local self-diagnostic system by adding **subcode -0066** to the product's ordinary code when ordering. The self-diagnosis module is equipped with an advanced microprocessor device, enabling it to perform various checks automatically and autonomously at certain time periods.

The module performs two types of tests at different periodic intervals:

- 1) **functionality test:** a short test is conducted automatically to verify the luminaire's operation.
- 2) **battery duration test:** automatically checks the battery's life by turning on the lamp for the pre-set interval. All signage is handled by one single tri-colour V-G-R LED, which indicates the kit's various operating statuses.

EM Centralised -0050



With emergency wiring with centralised power supply CLD EC sub-code -0050: permanent luminaire, with power supply unit operating in AC/DC, powered by a central emergency unit (not incorporated into the luminaire).

RECOMMENDED INSTALLATIONS:

- environments with very high ceilings (warehouses, distribution centres, hubs, etc.)
- environments where maintenance may be difficult (indoor swimming pools)
- large or multi-storey facilities where remote control is preferred (offices, hospitals, public places)

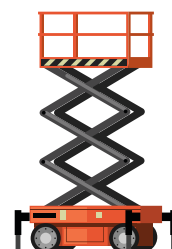

MAINTENANCE DOES NOT REQUIRE THE USE OF SPECIAL MACHINERY



MAINTENANCE CAN BE DONE DIRECTLY IN THE ELECTRICAL PANEL



REMOTE VERIFICATIONS CAN BE CONDUCTED



Creta

Creta is the new recessed LED **backlighting** ceiling fixture that opens up a whole different way of thinking about artificial lighting; it offers a very bright and diffused lighting, while keeping energy consumptions extremely low and setting itself as the ideal solution for general and functional lighting applications

Housing and frame: housing in galvanised steel sheet, and frame in aluminium, contact mounting on the cross T structure.

Optics: secondary lenses in PMMA with high transparency and non-yellowing properties.

UGR glare index: UGR<17 - EN 12464.

Wiring: rapid wiring connection, the fixture does not need to be opened.

v.a. IP20IK06
v.l. IP40IK06

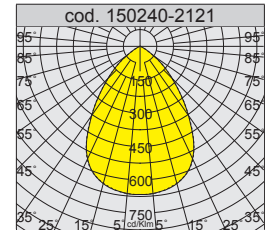
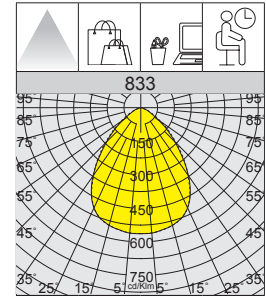
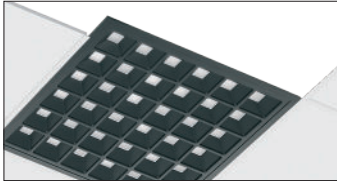
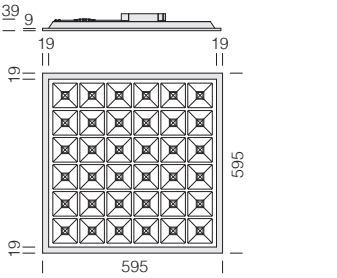

833 Creta - UGR<17

LED	colour	weight	CLD	CLD D-D (DALI)	W tot	LUMEN OUTPUT (tq= 25 °C)	+ Kit acc 600	% EM operation	
			code	code		K - ølm - CRI		h	%
LED	white	1.70	150240-00	150240-0041	31	4000K - 3980lm - CRI 80	986604-00	1h	13%
			150240-39	150240-3941		3000K - 3789lm - CRI 80	986604-31	3h	6%
LED	black	1.70	150240-2121	150240-2141	31	4000K - 2489lm - CRI 80	986604-00	1h	13%
							986604-31	3h	6%

EM versions: use kit acc. 600.

W tot: when the battery is charging, the power consumption (W tot) will exceed 3 watts. During maintenance (when the battery is charging), the total power (W tot) will exceed a value ranging between 0.5 and 1 watt.

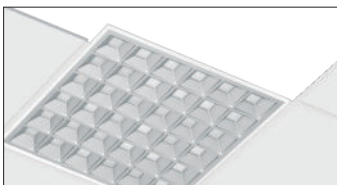

Available in silver color, with sub-code **-2118**

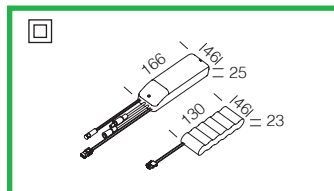

acc. 600 EM power kit

1h	986604-00
3h	986604-31

EM (emergency) lamp power kit complete with connectors. 0.43 Kg.



833 Creta - EM ED 1h - UGR<17

EM ED 1h: complete with emergency system with standard DALI protocol (inverter only). The -95 equipped product will remain ON-OFF and not DALI dimmable. W tot: when the battery is charging, the power consumption (W tot) will exceed 3 watts. During maintenance (when the battery is charging), the total power (W tot) will exceed a value ranging between 0.5 and 1 watt.

LED	colour	weight	CLD ED	W tot	LUMEN OUTPUT (tq= 25 °C)
			code		K - ølm - CRI
LED	white	2.20	150240-95	31	4000K - 3980lm - CRI 80
			150240-9528		3000K - 3789lm - CRI 80
LED	black	2.20	150240-9521	31	4000K - 2489lm - CRI 80



833 Creta - EM AD 1h - UGR<17

EM AD 1h: complete with emergency system and self-diagnosis module. W tot: when the battery is charging, the power consumption (W tot) will exceed 3 watts. During maintenance (when the battery is charging), the total power (W tot) will exceed a value ranging between 0.5 and 1 watt.

LED	colour	weight	CLD - Self-diagnosis	W tot	LUMEN OUTPUT (tq= 25 °C)
			code		K - ølm - CRI
LED	white	2.20	150240-0066	31	4000K - 3980lm - CRI 80
			150240-3966		3000K - 3789lm - CRI 80



833 Creta - EM EC - UGR<17

EM EC: with emergency wiring supplied by centralised power unit: permanent luminaire, with power supply unit operating in AC/DC, powered by a central emergency unit (NOT incorporated into the luminaire).

LED	colour	weight	CLD EC	W tot	LUMEN OUTPUT (tq= 25 °C)
			code		K - ølm - CRI
LED	white	1.70	150240-0050	31	4000K - 3980lm - CRI 80
			150240-3950		3000K - 3789lm - CRI 80
LED	black	1.70	150240-2150	31	4000K - 2489lm - CRI 80



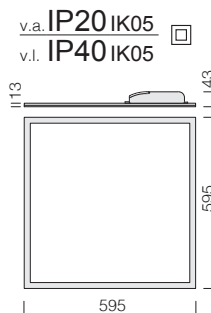
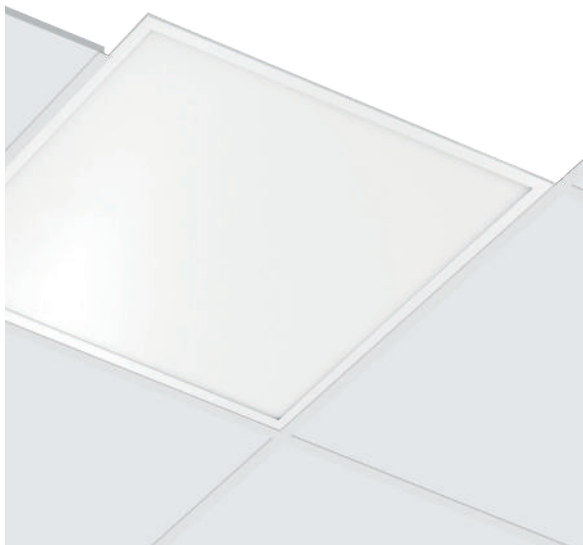
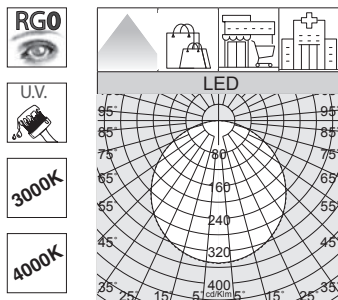

DIP SWITCH SETTING			LUMEN OUTPUT (tq= 25 °C)	
I out	W tot	K	Ølm	CRI
850	28	4000K	3024lm	CRI>80
900	30	4000K	3202lm	CRI>80
950	31	4000K	3381lm	CRI>80
1050	34	4000K	3738lm	CRI>80

DIP SWITCH SETTING			LUMEN OUTPUT (tq= 25 °C)	
I out	W tot	K	Ølm	CRI
850	28	3000K	2873lm	CRI>80
900	30	3000K	3042lm	CRI>80
950	31	3000K	3212lm	CRI>80
1050	34	3000K	3551lm	CRI>80

Lumen maintenance (lm) with EM kit: see table on page 7

Pannello B - DIP SWITCH



LED	colour	weight	CLD code	I out	W tot	LUMEN OUTPUT (tq= 25 °C)	+ Kit EM	% EM operation	
						K - Ølm - CRI		h	%
LED	white	2.40	22184301-00	900	30	4000K - 3202lm - CRI>80	22096035-00	1h	14%
			22184301-39			3000K - 3042lm - CRI>80	22096037-00	3h	6%
						3000K - 3042lm - CRI>80	22096035-00	1h	14%
							22096037-00	3h	6%

EM versions: use power kit in EM. **W tot:** when the battery is charging, the power consumption (W tot) will exceed 3 watts. During maintenance (when the battery is charging), the total power (W tot) will exceed a value ranging between 0.5 and 1 watt.

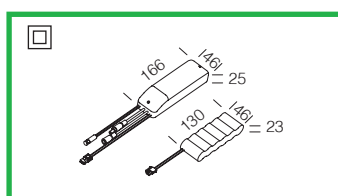

EM power kit

1h	22096035-00
3h	22096037-00

EM (emergency) lamp power kit complete with connectors. 0.43 Kg.

Pannello B - EM AD 1h - DIP SWITCH



LED	colour	weight	CLD - Self-diagnosis code	I out	W tot	LUMEN OUTPUT (tq= 25 °C)
						K - Ølm - CRI
LED	white	2.90	22184301-0066	900	30	4000K - 3202lm - CRI>80
			22184301-3966			3000K - 3042lm - CRI>80

EM AD 1h: complete with emergency system and self-diagnosis module. **W tot:** when the battery is charging, the power consumption (W tot) will exceed 3 watts. During maintenance (when the battery is charging), the total power (W tot) will exceed a value ranging between 0.5 and 1 watt.

Pannello B - EM EC - DIP SWITCH



LED	colour	weight	CLD EC code	I out	W tot	LUMEN OUTPUT (tq= 25 °C)
						K - Ølm - CRI
LED	white	2.40	22184301-0050	900	30	4000K - 3202lm - CRI>80
			22184301-3950			3000K - 3042lm - CRI>80

EM EC: with emergency wiring supplied by centralised power unit: permanent luminaire, with power supply unit operating in AC/DC, powered by a central emergency unit (NOT incorporated into the luminaire).

Pannello B

Inner slab: in PMMA.

ADAPT THE CURRENT TO ACHIEVE OPTIMAL LUMINOUS FLUX

DIP SWITCH SETTING: the fixture comes with a *DIP SWITCH* driver for **THE SETTING OF THE OUTPUT CURRENT**. In this way you, can **ENSURE THE BEST LUMINOUS FLUX** for any lighting design.

The possibility to choose the correct drive current for LEDs will allow you to have the right power under specific design conditions. Using a lower current will improve the efficiency of fixtures and therefore increase energy savings, whilst a higher current will result in a higher light flux so that you can reduce the number of fixtures.

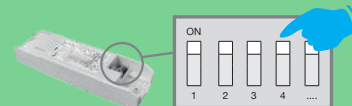

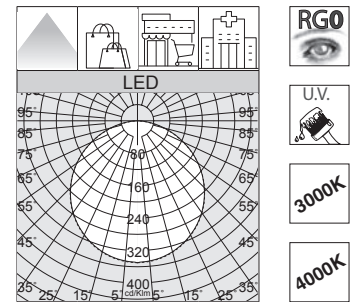
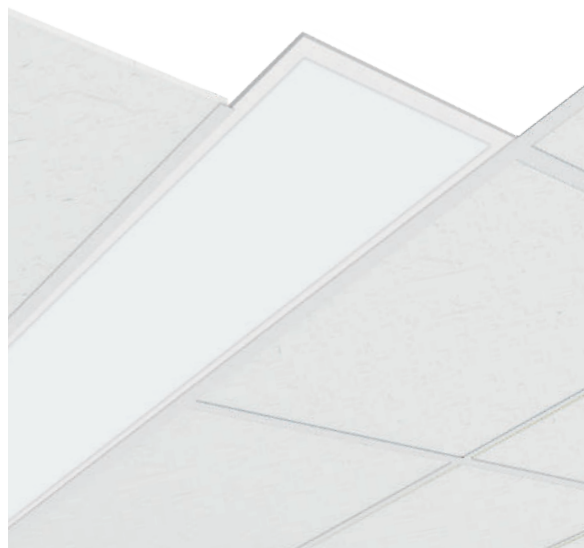
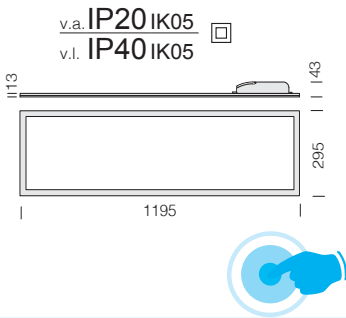

DIP SWITCH SETTING		
LUMEN OUTPUT (tq= 25 °C)		
I out	W tot	K - ølm - CRI
650	25	4000K - 2858lm - CRI>80
700	27	4000K - 3079lm - CRI>80
800	31	4000K - 3517lm - CRI>80
850	34	4000K - 3738lm - CRI>80

DIP SWITCH SETTING		
LUMEN OUTPUT (tq= 25 °C)		
I out	W tot	K - ølm - CRI
650	25	3000K - 2715lm - CRI>80
700	27	3000K - 2924lm - CRI>80
800	31	3000K - 3341lm - CRI>80
850	34	3000K - 3551lm - CRI>80

Lumen maintenance (lm) with EM kit: see table on page 7

Pannello B - R2 - DIP SWITCH

LED	colour	weight	CLD	LUMEN OUTPUT (tq= 25 °C)		+ Kit EM	% EM operation		
				I out	W tot		h	%	
LED	white	2.60	22185204-00	850	34	4000K - 3738lm - CRI>80	22096035-00	1h	12%
							22096037-00	3h	5%
			22185204-39			22096035-00	1h	12%	
						22096037-00	3h	5%	

EM versions: use power kit in EM. **W tot:** when the battery is charging, the power consumption (W tot) will exceed 3 watts. During maintenance (when the battery is charging), the total power (W tot) will exceed a value ranging between 0.5 and 1 watt.

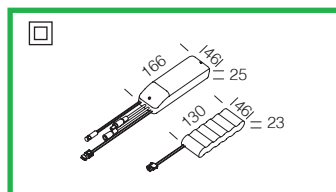

EM power kit	
1h	22096035-00
3h	22096037-00

EM (emergency) lamp power kit complete with connectors. 0.43 Kg. Max 54W.

EM AD 1h: complete with emergency system and self-diagnosis module. **W tot:** when the battery is charging, the power consumption (W tot) will exceed 3 watts. During maintenance (when the battery is charging), the total power (W tot) will exceed a value ranging between 0.5 and 1 watt.

Pannello B - R2 - EM AD 1h - DIP SWITCH

LED	colour	weight	CLD - Self-diagnosis		LUMEN OUTPUT (tq= 25 °C)	
			I out	W tot	K - ølm - CRI	
LED	white	3.10	850	34	22185204-0066	4000K - 3738lm - CRI>80
					22185204-3966	3000K - 3551lm - CRI>80

EM EC: with emergency wiring supplied by centralised power unit: permanent luminaire, with power supply unit operating in AC/DC, powered by a central emergency unit (NOT incorporated into the luminaire).

Pannello B - R2 - EM EC - DIP SWITCH

LED	colour	weight	CLD EC		LUMEN OUTPUT (tq= 25 °C)	
			I out	W tot	K - ølm - CRI	
LED	white	2.60	850	34	22185204-0050	4000K - 3738lm - CRI>80
					22185204-3950	3000K - 3551lm - CRI>80



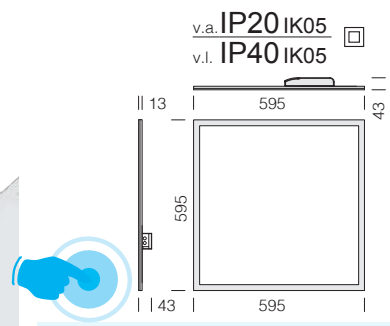
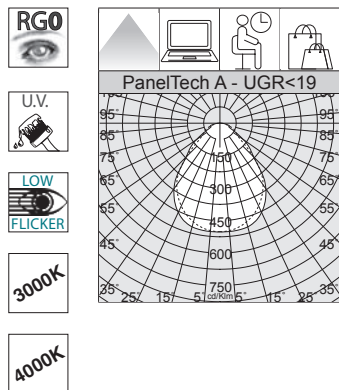

DIP SWITCH SETTING			LUMEN OUTPUT (tq= 25 °C)	
I out	W tot	K	ølm	CRI
850	28	4000K	3072lm	CRI>80
900	30	4000K	3229lm	CRI>80
950	31	4000K	3385lm	CRI>80
1050	34	4000K	3703lm	CRI>80

DIP SWITCH SETTING			LUMEN OUTPUT (tq= 25 °C)	
I out	W tot	K	ølm	CRI
850	28	3000K	2921lm	CRI>80
900	30	3000K	3069lm	CRI>80
950	31	3000K	3218lm	CRI>80
1050	34	3000K	3521lm	CRI>80

Lumen maintenance (lm) with EM kit: see table on page 7

PanelTech A - UGR<19 - DIP SWITCH

LED	colour	weight	CLD		LUMEN OUTPUT (tq= 25 °C)		+ Kit EM	% EM operation	
			code	I out	W tot	K		ølm	CRI
LED	white	2.40	22184802-00	950	31	4000K - 3385lm - CRI>80	22096035-00	1h	13%
			22184802-39			3000K - 3218lm - CRI>80	22096037-00	3h	6%
							22096035-00	1h	13%
							22096037-00	3h	6%

EM versions: use power kit in EM. W tot: when the battery is charging, the power consumption (W tot) will exceed 3 watts. During maintenance (when the battery is charging), the total power (W tot) will exceed a value ranging between 0.5 and 1 watt.

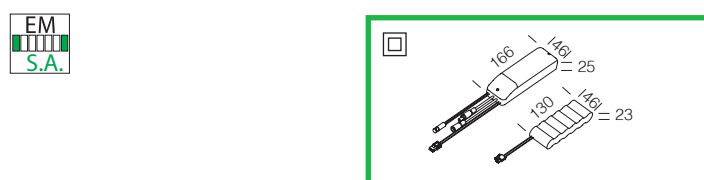

EM power kit	
1h	22096035-00
3h	22096037-00

EM (emergency) lamp power kit complete with connectors. 0.43 Kg.

PanelTech A - EM AD 1h - UGR<19 - DIP SWITCH

LED	colour	weight	CLD - Self-diagnosis		LUMEN OUTPUT (tq= 25 °C)	
			code	I out	W tot	K
LED	white	2.90	22184802-0066	950	31	4000K - 3385lm - CRI>80
			22184802-3966			3000K - 3218lm - CRI>80

EM AD 1h: complete with emergency system and self-diagnosis module. W tot: when the battery is charging, the power consumption (W tot) will exceed 3 watts. During maintenance (when the battery is charging), the total power (W tot) will exceed a value ranging between 0.5 and 1 watt.

PanelTech A - EM EC - UGR<19 - DIP SWITCH

LED	colour	weight	CLD EC		LUMEN OUTPUT (tq= 25 °C)	
			code	I out	W tot	K
LED	white	2.40	22184802-0050	950	31	4000K - 3385lm - CRI>80
			22184802-3950			3000K - 3218lm - CRI>80

EM EC: with emergency wiring supplied by centralised power unit: permanent luminaire, with power supply unit operating in AC/DC, powered by a central emergency unit (NOT incorporated into the luminaire).

PanelTech

Inner slab: in PMMA.
Diffuser: in prismatic engineering plastic with high transmittance.

ADAPT THE CURRENT TO ACHIEVE OPTIMAL LUMINOUS FLUX

DIP SWITCH SETTING: the fixture comes with a DIP SWITCH driver for THE SETTING OF THE OUTPUT CURRENT. In this way you, can ENSURE THE BEST LUMINOUS FLUX for any lighting design.

The possibility to choose the correct drive current for LEDs will allow you to have the right power under specific design conditions. Using a lower current will improve the efficiency of fixtures and therefore increase energy savings, whilst a higher current will result in a higher light flux so that you can reduce the number of fixtures.

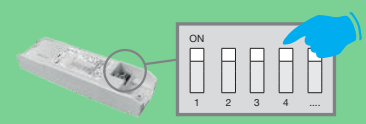

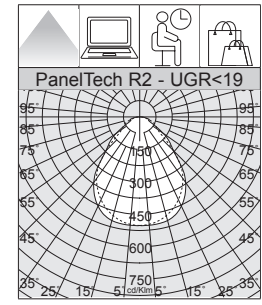
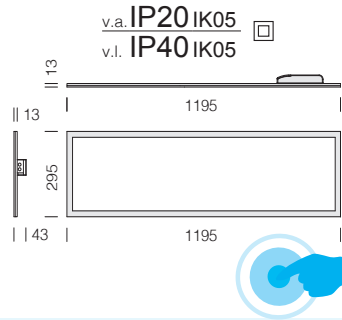

- RG0
- U.V.
- LOW FLICKER
- 3000K
- 4000K

DIP SWITCH SETTING		
LUMEN OUTPUT (tq= 25 °C)		
I out	W tot	K - ølm - CRI
650	25	4000K - 2786lm - CRI>80
700	27	4000K - 3000lm - CRI>80
800	31	4000K - 3429lm - CRI>80
850	34	4000K - 3643lm - CRI>80

DIP SWITCH SETTING		
LUMEN OUTPUT (tq= 25 °C)		
I out	W tot	K - ølm - CRI
650	25	3000K - 2646lm - CRI>80
700	27	3000K - 2850lm - CRI>80
800	31	3000K - 3258lm - CRI>80
850	34	3000K - 3461lm - CRI>80

Lumen maintenance (lm) with EM kit: see table on page 7

PanelTech R2 - UGR<19 - DIP SWITCH

LED	colour	weight	CLD code	I out	W tot	LUMEN OUTPUT (tq= 25 °C)		+ Kit EM		% EM operation	
						K - ølm - CRI				h	%
LED	white	2.60	22185205-00	800	31	4000K - 3429lm - CRI>80		22096035-00	1h	13%	
			22185205-39			3000K - 3258lm - CRI>80		22096037-00	3h	6%	
LED	white	2.60	22185205-00	800	31	4000K - 3429lm - CRI>80		22096035-00	1h	13%	
			22185205-39			3000K - 3258lm - CRI>80		22096037-00	3h	6%	



EM versions: use power kit in EM. **W tot:** when the battery is charging, the power consumption (W tot) will exceed 3 watts. During maintenance (when the battery is charging), the total power (W tot) will exceed a value ranging between 0.5 and 1 watt.

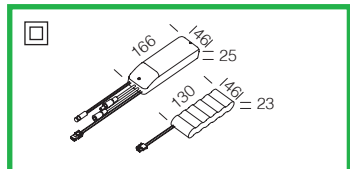

EM power kit	
1h	22096035-00
3h	22096037-00

EM (emergency) lamp power kit complete with connectors. 0.43 Kg. Max 54W.



EM AD 1h: complete with emergency system and self-diagnosis module. **W tot:** when the battery is charging, the power consumption (W tot) will exceed 3 watts. During maintenance (when the battery is charging), the total power (W tot) will exceed a value ranging between 0.5 and 1 watt.

PanelTech R2 - EM AD 1h - UGR<19 - DIP SWITCH

LED	colour	weight	CLD - Self-diagnosis		I out	W tot	LUMEN OUTPUT (tq= 25 °C)	
			code				K - ølm - CRI	
LED	white	3.10	22185205-0066		800	31	4000K - 3429lm - CRI>80	
			22185205-3966				3000K - 3258lm - CRI>80	



EM EC: with emergency wiring supplied by centralised power unit: permanent luminaire, with power supply unit operating in AC/DC, powered by a central emergency unit (NOT incorporated into the luminaire).

PanelTech R2 - EM EC - UGR<19 - DIP SWITCH

LED	colour	weight	CLD EC		I out	W tot	LUMEN OUTPUT (tq= 25 °C)	
			code				K - ølm - CRI	
LED	white	2.60	22185205-0050		800	31	4000K - 3429lm - CRI>80	
			22185205-3950				3000K - 3258lm - CRI>80	

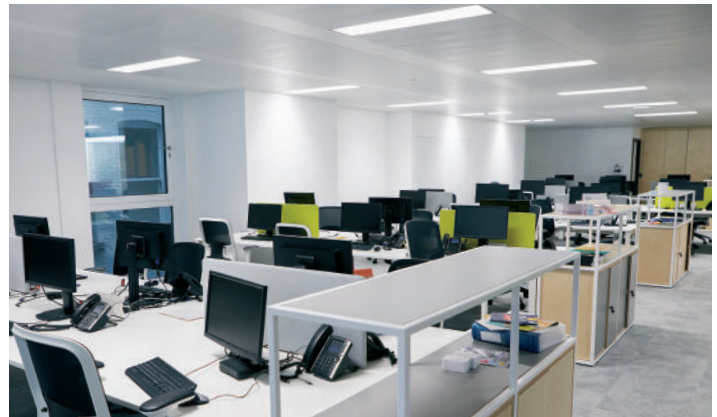

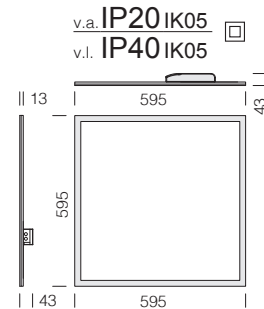
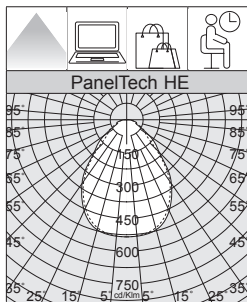

PanelTech HE A2 - UGR<19



		CLD		CLD D-DIG (DALI)	W tot	LUMEN OUTPUT (tq= 25 °C)	+ Kit EM	% EM operation	
LED	colour	weight	code	code		K - ølm - CRI		h	%
LED	white	2.40	22184806-00	22184806-1241	27	4000K - 3585lm - CRI>80	22096035-00	1h	15%
							22096037-00	3h	6%

EM versions: use power kit in EM. **W tot:** when the battery is charging, the power consumption (W tot) will exceed 3 watts. During maintenance (when the battery is charging), the total power (W tot) will exceed a value ranging between 0.5 and 1 watt.

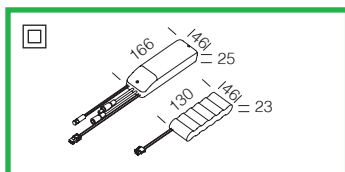

EM power kit

1h	22096035-00
3h	22096037-00

EM (emergency) lamp power kit complete with connectors. 0.43 Kg.

PanelTech HE A2 - EM ED 1h - UGR<19



		CLD ED		W tot	LUMEN OUTPUT (tq= 25 °C)
LED	colour	weight	code		K - ølm - CRI
LED	white	2.90	22184806-95	27	4000K - 3585lm - CRI>80

EM ED 1h: complete with emergency system with standard DALI protocol (inverter only). The -95 equipped product will remain ON-OFF and not DALI dimmable. W tot: when the battery is charging, the power consumption (W tot) will exceed 3 watts. During maintenance (when the battery is charging), the total power (W tot) will exceed a value ranging between 0.5 and 1 watt.

PanelTech HE A2 - EM AD 1h - UGR<19



		CLD - Self-diagnosis		W tot	LUMEN OUTPUT (tq= 25 °C)
LED	colour	weight	code		K - ølm - CRI
LED	white	2.90	22184806-0066	27	4000K - 3585lm - CRI>80

EM AD 1h: complete with emergency system and self-diagnosis module. W tot: when the battery is charging, the power consumption (W tot) will exceed 3 watts. During maintenance (when the battery is charging), the total power (W tot) will exceed a value ranging between 0.5 and 1 watt.

PanelTech HE A2 - EM EC - UGR<19



		CLD EC		W tot	LUMEN OUTPUT (tq= 25 °C)
LED	colour	weight	code		K - ølm - CRI
LED	white	2.40	22184806-0050	27	4000K - 3585lm - CRI>80

EM EC: with emergency wiring supplied by centralised power unit: permanent luminaire, with power supply unit operating in AC/DC, powered by a central emergency unit (NOT incorporated into the luminaire).



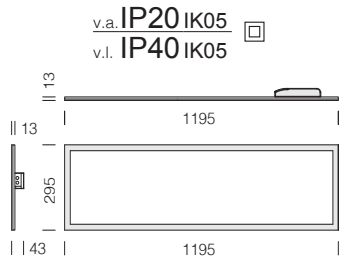

REAL UGR<19!

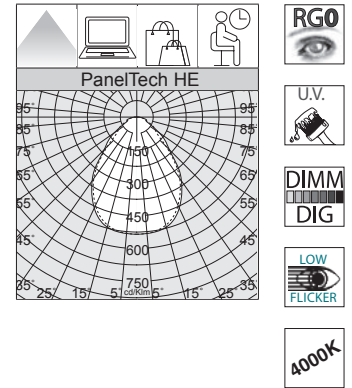

PanelTech HE R2 - UGR<19

		CLD		CLD D-DIG (DALI)	LUMEN OUTPUT (tq= 25 °C)		+ Kit EM	% EM operation	
LED	colour	weight	code	code	W tot	K - ølm - CRI		h	%
LED	white	2.60	22185203-00	22185203-1241	27	4000K - 3527lm - CRI>80	22096035-00	1h	15%
							22096037-00	3h	6%

EM versions: use power kit in EM. **W tot:** when the battery is charging, the power consumption (W tot) will exceed 3 watts. During maintenance (when the battery is charging), the total power (W tot) will exceed a value ranging between 0.5 and 1 watt.

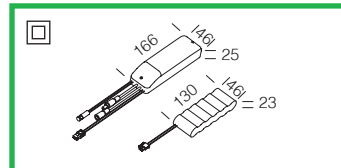

EM power kit

1h	22096035-00
3h	22096037-00

EM (emergency) lamp power kit complete with connectors. 0.43 Kg.

PanelTech HE R2 - EM ED 1h - UGR<19

EM ED 1h: complete with emergency system with standard DALI protocol (inverter only). The -95 equipped product will remain ON-OFF and not DALI dimmable. W tot: when the battery is charging, the power consumption (W tot) will exceed 3 watts. During maintenance (when the battery is charging), the total power (W tot) will exceed a value ranging between 0.5 and 1 watt.

		CLD ED		LUMEN OUTPUT (tq= 25 °C)	
LED	colour	weight	code	W tot	K - ølm - CRI
LED	white	3.10	22185203-95	27	4000K - 3527lm - CRI>80

PanelTech HE R2 - EM AD 1h - UGR<19

EM AD 1h: complete with emergency system and self-diagnosis module. W tot: when the battery is charging, the power consumption (W tot) will exceed 3 watts. During maintenance (when the battery is charging), the total power (W tot) will exceed a value ranging between 0.5 and 1 watt.

		CLD - Self-diagnosis		LUMEN OUTPUT (tq= 25 °C)	
LED	colour	weight	code	W tot	K - ølm - CRI
LED	white	3.10	22185203-0066	27	4000K - 3527lm - CRI>80

PanelTech HE R2 - EM EC - UGR<19

EM EC: with emergency wiring supplied by centralised power unit: permanent luminaire, with power supply unit operating in AC/DC, powered by a central emergency unit (NOT incorporated into the luminaire).

		CLD EC		LUMEN OUTPUT (tq= 25 °C)	
LED	colour	weight	code	W tot	K - ølm - CRI
LED	white	2.60	22185203-0050	27	4000K - 3527lm - CRI>80

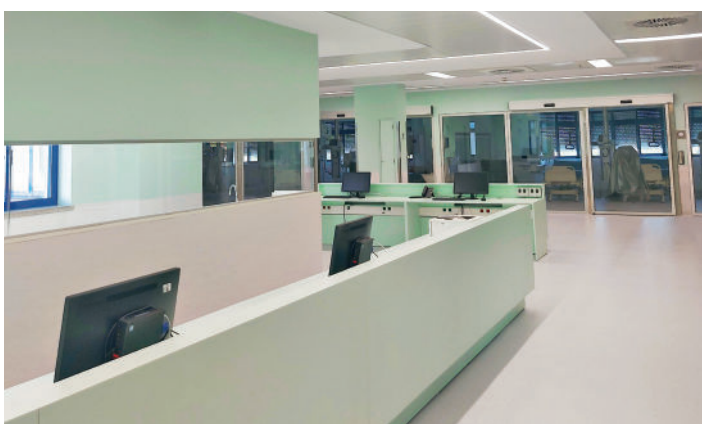

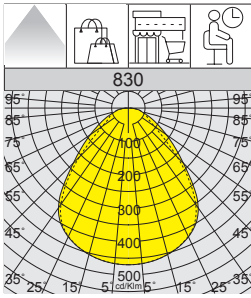

v.a. IP20IK06
v.l. IP40IK06

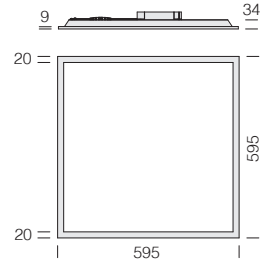

830 Rodi - UGR<19



LED	colour	CLD		CLD D-D (DALI)		W tot	LUMEN OUTPUT (tq= 25 °C)		+ kit EM acc 600		% EM operation	
		weight	L	code	code		K - ølm - CRI	h	%			
LED	white	1.30	595	150242-00	150242-0041	25	4000K - 3640lm - CRI 80		986604-00	1h	16%	
				150242-39	150242-3941		3000K - 3458lm - CRI 80		986604-31	3h	7%	
		1.30	595	150245-00	150245-0041	28	4000K - 4050lm - CRI 80		986604-00	1h	16%	
				986604-31	3h		7%					

Versioni EM: utilizzare il kit acc. 600.

Wtot: in fase di ricarica della batteria, il consumo (Wtot) sarà maggiore di 3W. In fase di mantenimento (quando la batteria è carica) la potenza (Wtot) sarà maggiore di un valore compreso tra 0,5 e 1W.

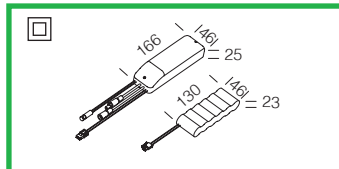

acc. 600 EM power kit

1h	986604-00
3h	986604-31

EM (emergency) lamp power kit complete with connectors. 0.43 Kg.

acc. 907 springs

998038-00

Springs for recessed non-surface mounting on plasterboard. Bag containing 4 pieces.

590x590
290x1190



830 Rodi - EM ED 1h - UGR<19

LED	colour	CLD ED		W tot	LUMEN OUTPUT (tq= 25 °C)	
		weight	L		code	K - ølm - CRI
LED	white	1.30	595	150242-95	25	4000K - 3640lm - CRI 80
				150242-9528		3000K - 3458lm - CRI 80
		1.30	595	150245-95	28	4000K - 4050lm - CRI 80

EM ED 1h: complete with emergency system with standard DALI protocol (inverter only). The -95 equipped product will remain ON-OFF and not DALI dimmable. W tot: when the battery is charging, the power consumption (W tot) will exceed 3 watts. During maintenance (when the battery is charging), the total power (W tot) will exceed a value ranging between 0.5 and 1 watt.



830 Rodi - EM AD 1h - UGR<19

LED	colour	CLD - Self-diagnosis		W tot	LUMEN OUTPUT (tq= 25 °C)	
		weight	L		code	K - ølm - CRI
LED	white	1.30	595	150242-0066	25	4000K - 3640lm - CRI 80
				150242-3966		3000K - 3458lm - CRI 80
		1.30	595	150245-0066	28	4000K - 4050lm - CRI 80

EM AD 1h: complete with emergency system and self-diagnosis module. W tot: when the battery is charging, the power consumption (W tot) will exceed 3 watts. During maintenance (when the battery is charging), the total power (W tot) will exceed a value ranging between 0.5 and 1 watt.



830 Rodi - EM EC - UGR<19

LED	colour	CLD EC		W tot	LUMEN OUTPUT (tq= 25 °C)	
		weight	L		code	K - ølm - CRI
LED	white	1.30	595	150242-0050	25	4000K - 3640lm - CRI 80
				150242-3950		3000K - 3458lm - CRI 80
		1.30	595	150245-0050	28	4000K - 4050lm - CRI 80

EM EC: with emergency wiring supplied by centralised power unit: permanent luminaire, with power supply unit operating in AC/DC, powered by a central emergency unit (NOT incorporated into the luminaire).

v.a. IP20 IK07
v.l. IP44 IK07

min Ø 200
max Ø 240

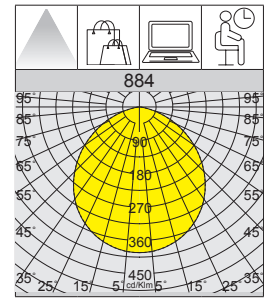
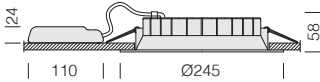

884 Compact - CRI 95 - Ø245 - DIP SWITCH

LED	colour	weight	CLD		I out	W tot	LUMEN OUTPUT (tq= 25 °C)		+ kit EM acc 600		% EM operation	
			code				K - ølm - CRI		h	%		
LED	white	0.70	156424-00		500	18	4000K - 2385lm - CRI 95		986605-00	1h	23%	
			156424-39				3000K - 2266lm - CRI 95		986605-31	3h	10%	
LED	white	0.70	156425-00		700	25	4000K - 3342lm - CRI 95		986605-00	1h	16%	
			156425-39				3000K - 3175lm - CRI 95		986605-31	3h	7%	



EM versions: use kit acc. 600. **W tot:** when the battery is charging, the power consumption (W tot) will exceed 3 watts. During maintenance (when the battery is charging), the total power (W tot) will exceed a value ranging between 0.5 and 1 watt.

acc. 600 EM power kit

1h	986605-00
3h	986605-31

EM (emergency) lamp power kit complete with connectors. 0.43 Kg.

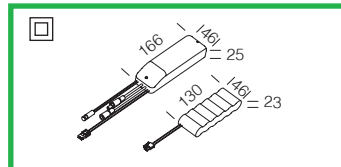

DIP SWITCH SETTING		LUMEN OUTPUT (tq= 25 °C)	
I out	W tot	K - ølm - CRI	
450	14	4000K - 1926lm - CRI 95	
500	18	4000K - 2385lm - CRI 95	
550	20	4000K - 2626lm - CRI 95	
600	22	4000K - 2884lm - CRI 95	

DIP SWITCH SETTING		LUMEN OUTPUT (tq= 25 °C)	
I out	W tot	K - ølm - CRI	
450	14	3000K - 1854lm - CRI 95	
500	18	3000K - 2226lm - CRI 95	
550	20	3000K - 2503lm - CRI 95	
600	22	3000K - 2729lm - CRI 95	

DIP SWITCH SETTING		LUMEN OUTPUT (tq= 25 °C)	
I out	W tot	K - ølm - CRI	
700	25	4000K - 3342lm - CRI 95	
750	27	4000K - 3538lm - CRI 95	
800	29	4000K - 3775lm - CRI 95	

DIP SWITCH SETTING		LUMEN OUTPUT (tq= 25 °C)	
I out	W tot	K - ølm - CRI	
700	25	3000K - 3175lm - CRI 95	
750	27	3000K - 3362lm - CRI 95	
800	29	3000K - 3586lm - CRI 95	

Lumen maintenance (lm) with EM kit:
see table on page 7

884 Compact - EM AD 1h - CRI 95 - Ø245 - DIP SWITCH

LED	colour	weight	CLD - Self-diagnosis		I out	W tot	LUMEN OUTPUT (tq= 25 °C)	
			code				K - ølm - CRI	
LED	white	1.20	156424-0066		500	18	4000K - 2385lm - CRI 95	
			156424-3966				3000K - 2266lm - CRI 95	
LED	white	1.20	156425-0066		700	25	4000K - 3342lm - CRI 95	
			156425-3966				3000K - 3175lm - CRI 95	



Complete with emergency system and self-diagnosis module. W tot: when the battery is charging, the power consumption (W tot) will exceed 3 watts. During maintenance (when the battery is charging), the total power (W tot) will exceed a value ranging between 0.5 and 1 watt.

884 Compact - EM EC - CRI 95 - Ø245 - DIP SWITCH

LED	colour	weight	CLD EC		I out	W tot	LUMEN OUTPUT (tq= 25 °C)	
			code				K - ølm - CRI	
LED	white	0.70	156424-0050		500	18	4000K - 2385lm - CRI 95	
			156424-3950				3000K - 2266lm - CRI 95	
LED	white	0.70	156425-0050		700	25	4000K - 3342lm - CRI 95	
			156425-3950				3000K - 3175lm - CRI 95	



With emergency wiring supplied by centralised power unit: permanent luminaire, with power supply unit operating in AC/DC, powered by a central emergency unit (NOT incorporated into the luminaire).

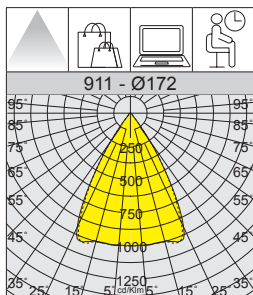

v.a. IP20 IK07
v.l. IP40 IK07

min Ø 150
max Ø 155

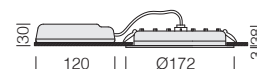

DIP SWITCH SETTING			LUMEN OUTPUT (tq= 25 °C)	
I out	W tot	K	ølm	CRI
350	13	4000K	- 1795lm	- CRI 80
500	19	4000K	- 2490lm	- CRI 80
600	22	4000K	- 2915lm	- CRI 80

DIP SWITCH SETTING			LUMEN OUTPUT (tq= 25 °C)	
I out	W tot	K	ølm	CRI
350	13	3000K	- 1669lm	- CRI 80
500	19	3000K	- 2316lm	- CRI 80
600	22	3000K	- 2711lm	- CRI 80

Lumen maintenance (lm) with EM kit:
see table on page 7



911 Health Dark - UGR<19 - Ø172 - DIP SWITCH



LED		colour		weight	Ø	CLD		code		I out	W tot	LUMEN OUTPUT (tq= 25 °C)		K	ølm	CRI	+ Kit acc 600	% EM operation	
																		h	%
LED	white	0.50	172	156473-00		500	19	4000K - 2490lm - CRI 80		500	19	4000K - 2490lm - CRI 80		4000K	2490lm	CRI 80	986604-00	1h	22%
				156473-39				3000K - 2316lm - CRI 80				986604-31	3h				9%		
																	986604-00	1h	22%
																	986604-31	3h	9%

EM versions: use kit acc. 600. **W tot:** when the battery is charging, the power consumption (W tot) will exceed 3 watts. During maintenance (when the battery is charging), the total power (W tot) will exceed a value ranging between 0.5 and 1 watt.

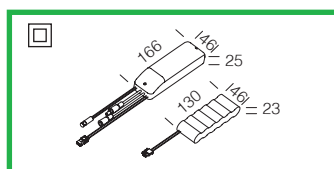

acc. 600 EM power kit

1h	986604-00
3h	986604-31

EM (emergency) lamp power kit complete with connectors. 0.43 Kg.



911 Health Dark - EM AD 1h - UGR<19 - Ø172 - DIP SWITCH

LED		colour		weight	Ø	CLD - Self-diagnosis		code		I out	W tot	LUMEN OUTPUT (tq= 25 °C)		K	ølm	CRI
LED	white	1.00	172	156473-0066		500	19	4000K - 2490lm - CRI 80		500	19	4000K - 2490lm - CRI 80		4000K	2490lm	CRI 80
				156473-3966				3000K - 2316lm - CRI 80								

EM AD 1h: complete with emergency system and self-diagnosis module. **W tot:** when the battery is charging, the power consumption (W tot) will exceed 3 watts. During maintenance (when the battery is charging), the total power (W tot) will exceed a value ranging between 0.5 and 1 watt.



911 Health Dark - EM EC - UGR<19 - Ø172 - DIP SWITCH

LED		colour		weight	Ø	CLD EC		code		I out	W tot	LUMEN OUTPUT (tq= 25 °C)		K	ølm	CRI
LED	white	0.50	172	156473-0050		500	19	4000K - 2490lm - CRI 80		500	19	4000K - 2490lm - CRI 80		4000K	2490lm	CRI 80
				156473-3950				3000K - 2316lm - CRI 80								

EM EC: with emergency wiring supplied by centralised power unit: permanent luminaire, with power supply unit operating in AC/DC, powered by a central emergency unit (NOT incorporated into the luminaire).

Health Dark

Housing: fixed dondwlight in die cast aluminium.

Lens: in PMMA lens with high efficiency output and very low glare rate.

Dark light optics: in anti-glare metalized plastic material.

ADAPT THE CURRENT TO ACHIEVE OPTIMAL LUMINOUS FLUX

DIP SWITCH SETTING: the fixture comes with a **DIP SWITCH** driver for **THE SETTING OF THE OUTPUT CURRENT**. In this way you, can **ENSURE THE BEST LUMINOUS FLUX** for any lighting design.

The possibility to choose the correct drive current for LEDs will allow you to have the right power under specific design conditions. Using a lower current will improve the efficiency of fixtures and therefore increase energy savings, whilst a higher current will result in a higher light flux so that you can reduce the number of fixtures.

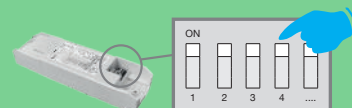

v.a. IP20 IK07
v.l. IP40 IK07

min Ø 200
max Ø 205

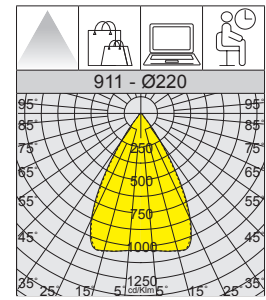
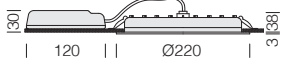

L80
B20
50.000h

RG0

U.V.

DARK
65% 500
LIGH#

LOW
FLICKER

4000K

DIP SWITCH SETTING			LUMEN OUTPUT (tq= 25 °C)	
I out	W tot		K - ølm - CRI	
600	22		4000K - 2900lm - CRI 80	
700	26		4000K - 3315lm - CRI 80	
800	30		4000K - 3740lm - CRI 80	

DIP SWITCH SETTING			LUMEN OUTPUT (tq= 25 °C)	
I out	W tot		K - ølm - CRI	
600	22		3000K - 2755lm - CRI 80	
700	26		3000K - 3149lm - CRI 80	
800	30		3000K - 3553lm - CRI 80	

Lumen maintenance (lm) with EM kit:
see table on page 7



911 Health Dark - UGR<19 - Ø220 - DIP SWITCH

LED	colore	weight	Ø	CLD		LUMEN OUTPUT (tq= 25 °C)		+ Kit acc 600	% funzionamento in EM	
				code		I out	W tot		K - ølm - CRI	h
LED	white	0.70	220	156477-00	800	30	4000K - 3740lm - CRI 80	986604-00	1h	14%
				156477-39			3000K - 3553lm - CRI 80	986604-31	3h	6%
								986604-00	1h	14%
								986604-31	3h	6%

EM versions: use kit acc. 600. **W tot:** when the battery is charging, the power consumption (W tot) will exceed 3 watts. During maintenance (when the battery is charging), the total power (W tot) will exceed a value ranging between 0.5 and 1 watt.

+ KIT
EM

acc. 600 EM power kit

1h	986604-00
3h	986604-31

EM (emergency) lamp power kit complete with connectors. 0.43 Kg.

EM
S.A.

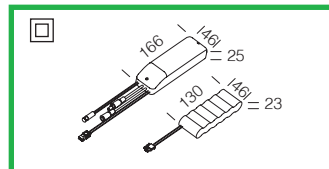

911 Health Dark - EM AD 1h - UGR<19 - Ø220 - DIP SWITCH

EM AD 1h: complete with emergency system and self-diagnosis module. **W tot:** when the battery is charging, the power consumption (W tot) will exceed 3 watts. During maintenance (when the battery is charging), the total power (W tot) will exceed a value ranging between 0.5 and 1 watt.

LED	colour	weight	Ø	CLD - Self-diagnosis		LUMEN OUTPUT (tq= 25 °C)	
				code		I out	W tot
LED	white	1.20	220	156477-0066	800	30	4000K - 3740lm - CRI 80
				156477-3966			3000K - 3553lm - CRI 80

-0066
AD

911 Health Dark - EM E C - UGR<19 - Ø220 - DIP SWITCH

EM EC: with emergency wiring supplied by centralised power unit: permanent luminaire, with power supply unit operating in AC/DC, powered by a central emergency unit (NOT incorporated into the luminaire).

LED	colour	weight	Ø	CLD EC		LUMEN OUTPUT (tq= 25 °C)	
				code		I out	W tot
LED	white	0.70	220	156477-0050	800	30	4000K - 3740lm - CRI 80
				156477-3950			3000K - 3553lm - CRI 80

-0050
EM-EC



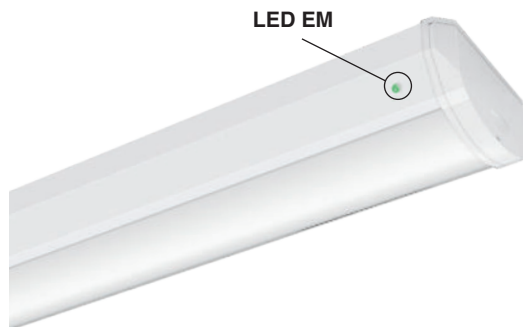
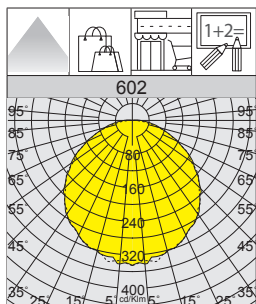

IP20IK06 □

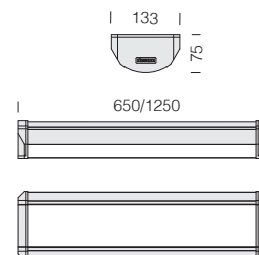

602 Disanlens - EM 1h - S.A.



LED	colour	L	weight	CLD E		LUMEN OUTPUT (tq= 25 °C)		% EM operation	
				code	W tot	K - ølm - CRI	h	%	
LED	white	650 mm	2.00	115597-07	15	4000K - 1720lm - CRI 80	1h	29%	
		1250 mm	3.20	115598-07	28	4000K - 3440lm - CRI 80	1h	15%	

602 Disanlens - EM AD 1h



LED	colour	L	weight	CLD - Self-diagnosis		LUMEN OUTPUT (tq= 25 °C)		% EM operation	
				code	W tot	K - ølm - CRI	h	%	
LED	white	650 mm	2.00	115597-0766	15	4000K - 1720lm - CRI 80	1h	29%	
		1250 mm	3.20	115598-0766	28	4000K - 3440lm - CRI 80	1h	15%	

602 Disanlens - EM EC



LED	colour	L	weight	CLD EC		LUMEN OUTPUT (tq= 25 °C)	
				code	W tot	K - ølm - CRI	
LED	white	650 mm	1.50	115597-0050	15	4000K - 1720lm - CRI 80	
		1250 mm	2.70	115598-0050	28	4000K - 3440lm - CRI 80	

EM EC: with emergency wiring supplied by centralised power unit: permanent luminaire, with power supply unit operating in AC/DC, powered by a central emergency unit (NOT incorporated into the luminaire).

INSTALLATION AND ACCESSORIES

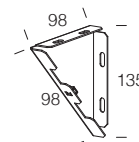
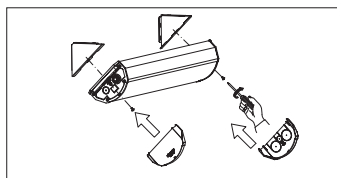
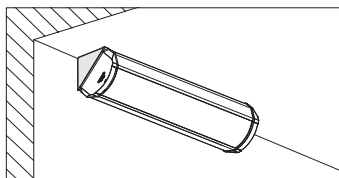

acc. 588 bracket
993971-00
Bracket for wall mounting. 2-pc set.

Disanlens 602

Housing: in extruded aluminium with closing ends.

Diffuser: in shatter-proof, self-extinguishing and UV-stabilised V2 polycarbonate. Smooth and dust-proof on the outside, and multiple grooves on the inside to increase light distribution.

Coating: smooth, white powder coating.

Equipment: silicone rubber gasket; outer screws in stainless steel.

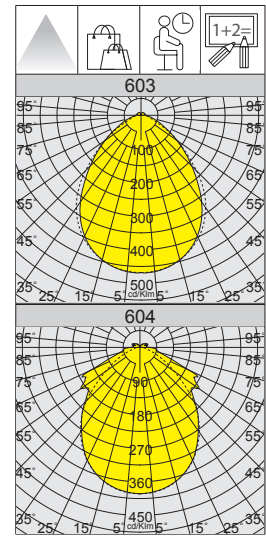
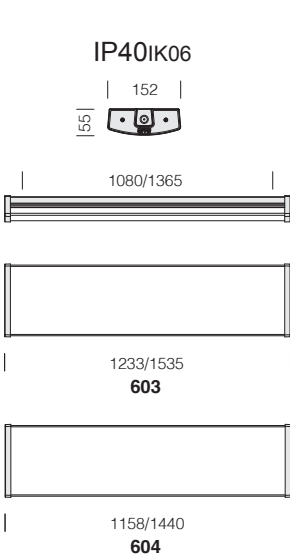

603 Disanlens - EM 1h S.A - UGR<19

LED	colour	L	weight	CLD E code	CLD D DE (DALI) code	W tot	LUMEN OUTPUT (tq= 25 °C) K - ølm - CRI	% EM operation	
LED	white	1233 mm	3.30	115521-07	115521-0741	23	4000K - 3450lm - CRI 80	1h	15%
		1535 mm	4.60	115522-07	115522-0741	30	4000K - 4800lm - CRI 80	1h	10%



603 Disanlens - EM ED 1h - UGR<19

LED	colour	L	weight	CLD ED code	W tot	LUMEN OUTPUT (tq= 25 °C) K - ølm - CRI	% EM operation	
LED	white	1233 mm	3.30	115521-95	23	4000K - 3450lm - CRI 80	1h	15%
		1535 mm	4.60	115522-95	30	4000K - 4800lm - CRI 80	1h	10%



603 Disanlens - EM AD 1h - UGR<19

LED	colour	L	weight	CLD - Self-diagnosis code	W tot	LUMEN OUTPUT (tq= 25 °C) K - ølm - CRI	% EM operation	
LED	white	1233 mm	3.30	115521-0766	23	4000K - 3450lm - CRI 80	1h	15%
		1535 mm	4.60	115522-0766	30	4000K - 4800lm - CRI 80	1h	10%



603 Disanlens - EM EC - UGR<19

LED	colour	L	weight	CLD EC code	W tot	LUMEN OUTPUT (tq= 25 °C) K - ølm - CRI
LED	white	1233 mm	2.80	115521-0050	23	4000K - 3450lm - CRI 80
		1535 mm	4.10	115522-0050	30	4000K - 4800lm - CRI 80



604 Disanlens - EM 1h - S.A.

LED	colour	L	weight	CLD E code	W tot	LUMEN OUTPUT (tq= 25 °C) K - ølm - CRI	% EM operation	
LED	white	1158 mm	3.30	115534-07	23	4000K - 3450lm - CRI 80	1h	15%
		1440 mm	4.60	115535-07	30	4000K - 4800lm - CRI 80	1h	10%



604 Disanlens - EM AD 1h

LED	colour	L	weight	CLD - Self-diagnosis code	W tot	LUMEN OUTPUT (tq= 25 °C) K - ølm - CRI	% EM operation	
LED	white	1158 mm	3.30	115534-0766	23	4000K - 3450lm - CRI 80	1h	15%
		1440 mm	4.60	115535-0766	30	4000K - 4800lm - CRI 80	1h	10%



604 Disanlens - EM EC

LED	colour	L	weight	CLD EC code	W tot	LUMEN OUTPUT (tq= 25 °C) K - ølm - CRI
LED	white	1158 mm	2.80	115534-0050	23	4000K - 3450lm - CRI 80
		1440 mm	4.10	115535-0050	30	4000K - 4800lm - CRI 80



EM EC: with emergency wiring supplied by centralised power unit: permanent luminaire, with power supply unit operating in AC/DC, powered by a central emergency unit (NOT incorporated into the luminaire).

Disanlens 603-604

Housing: in pre-coated and pre-galvanized sheet; ABS white thread ends with vandal-proof closure system.

Diffuser: in polycarbonate with micro-prismatic finish surface to control lighting distribution.

Equipment: complete with inlet cable gland and spacers to mount the fixture to the ceiling or wall..

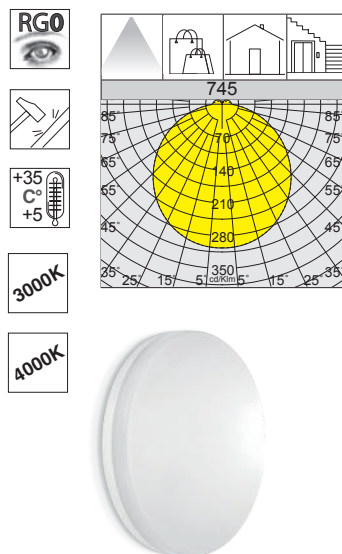

IP65IK07

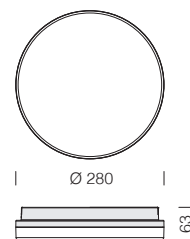

745 Oblò J 2.0 - EM 1h

LED	colour	weight	Ø mm	CLD E		LUMEN OUTPUT (tq= 25 °C)		% EM operation	
				code	W tot	K - ølm - CRI	h	%	
LED	white	1.50	280	112600-07	19	4000K - 2026lm - CRI>80	1h	5%	
				112600-0728		3000K - 1863lm - CRI>80			
LED	white	1.50	280	112601-07	24	4000K - 2898lm - CRI>80	1h	4%	
				112601-0728		3000K - 2695lm - CRI>80			

745 Oblò J 2.0 - EM 3h

LED	colour	weight	Ø mm	CLD E		LUMEN OUTPUT (tq= 25 °C)		% EM operation	
				code	W tot	K - ølm - CRI	h	%	
LED	white	1.50	280	112600-31	19	4000K - 2026lm - CRI>80	3h	5%	
				112600-3128		3000K - 1863lm - CRI>80			
LED	white	1.50	280	112601-31	24	4000K - 2898lm - CRI>80	3h	3%	
				112601-3128		3000K - 2695lm - CRI>80			

745 Oblò J 2.0 - EM 3h + SENSOR

LED	colour	weight	Ø mm	CLD E (3h) + sensor (ON-OFF)		LUMEN OUTPUT (tq= 25 °C)		% EM operation	
				code	W tot	K - ølm - CRI	h	%	
LED	white	1.50	280	112600-1957	19	4000K - 2026lm - CRI>80	3h	5%	
				112600-19573000		3000K - 1863lm - CRI>80			

745 Oblò J 2.0 - EM EC

LED	colour	weight	Ø mm	CLD EC		LUMEN OUTPUT (tq= 25 °C)	
				code	W tot	K - ølm - CRI	
LED	white	1.00	280	112600-0050	16	4000K - 2026lm - CRI>80	
				112600-3950		3000K - 1863lm - CRI>80	
LED	white	1.00	280	112601-0050	21	4000K - 2898lm - CRI>80	
				112601-3950		3000K - 2695lm - CRI>80	

EM EC: with emergency wiring supplied by centralised power unit: permanent luminaire, with power supply unit operating in AC/DC, powered by a central emergency unit (NOT incorporated into the luminaire).

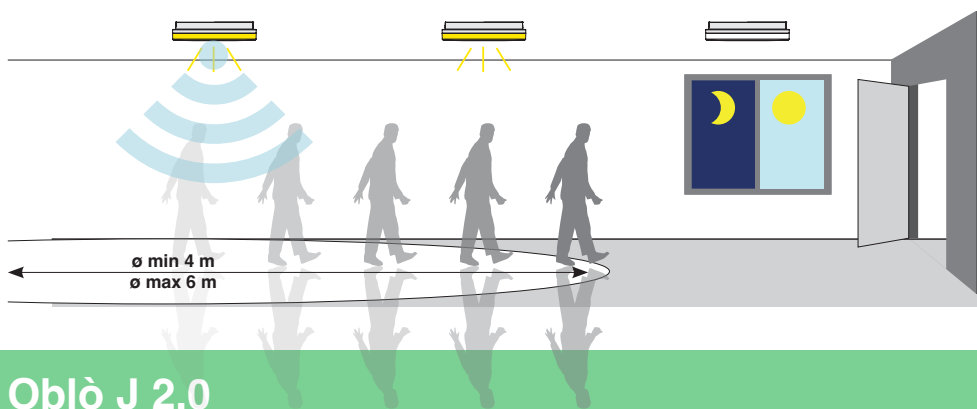

SENSOR - TECHNICAL SPECIFICATIONS

Detection area	75%
Detection distance	Ø 4-6 m (adjustable)
Hold time	1 min
Ambient light	Disable
Power consumption	~ 0,9 W
Microwave frequency/power	5.8GHz / <0.3mW
Operating temperature	-25°C ÷ 60°C

Oblò J 2.0

Housing: vandal-resistant, self-extinguishing polycarbonate.

Diffuser: In clear polycarbonate, anti-dazzle, vandal resistant.



Tortuga - EM 3h S.A.

LED	colour	weight	Ø mm	CLD E		LUMEN OUTPUT (tq= 25 °C)		% EM operation	
				code	W tot	K - ølm - CRI	h	%	
(1) LED	white	1.20	305	22042410-09	18	3000K - 1436lm - CRI>80	3h	12,5%	
				22042411-09		4000K - 1562lm - CRI>80	3h	12,5%	
(2) LED	white	1.60	400	22042412-09	30	3000K - 2523lm - CRI>80	3h	7%	
				22042413-09		4000K - 2744lm - CRI>80	3h	7%	

EM EC: with emergency wiring supplied by centralised power unit: permanent luminaire, with power supply unit operating in AC/DC, powered by a central emergency unit (NOT incorporated into the luminaire).

Tortuga - EM EC

LED	colour	weight	Ø mm	CLD EC		LUMEN OUTPUT (tq= 25 °C)	
				code	W tot	K - ølm - CRI	
(1) LED	white	0.70	305	22042410-0050	17	3000K - 1436lm - CRI>80	
				22042411-0050		4000K - 1562lm - CRI>80	
(2) LED	white	1.10	400	22042412-0050	28	3000K - 2523lm - CRI>80	
				22042413-0050		4000K - 2744lm - CRI>80	

Tortuga

Round-shape LED fixture with opal polycarbonate diffuser that can be easily installed to the ceiling/wall; ideal for entrance areas, corridors, stairways, waiting rooms, hotels, restaurants and residential spaces. Available in two sizes (ø305/400 mm) and in the standard 3000K/4000K version and in the 3h emergency version with light-presence sensor (ON-OFF).

Tortuga is the energy-efficient and modern alternative to luminaires with traditional light sources.

Housing: vandal-resistant, self-extinguishing polycarbonate.

Diffuser: In clear polycarbonate, anti-dazzle, vandal resistant.



The main feature of this fixture is the new colour-changing technology. With **two built-in switches** you can:

- select 2 different colour temperatures, adjusting to most installations
- select the type of output luminous flux and power.



IP65IK08

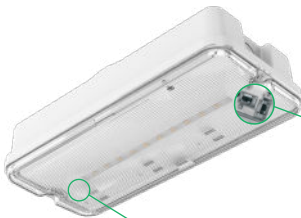
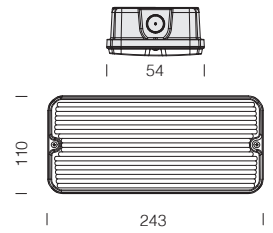

• switch for adjusting light flux and colour temperature (CCT)
standard configuration is 5700K and maximum power/flux values.



• can be configured for either Emergency Only (S.E.) mode or Maintained (S.A.) mode by directly wiring the electrical connections to the provided terminal block.

621 Safety 3.0 CCT - EM 1h S.E. Emergency Only - S.A. Maintained

		CLD CEM-L		CCT SWITCH		LUMEN OUTPUT S.E. (tq= 25 °C)		LUMEN OUTPUT S.A. (tq= 25 °C)	
LED	colour	weight	code	autonomy	Kelvin	W tot S.E.	K - ølm - CRI	W tot S.A.	K - ølm - CRI
LED	white	0.30	112533-00	1h	4000K/5700K	1	70lm/110lm/150lm - CRI 80	2/3/4	70lm/110lm/150lm - CRI 80
			112534-00		4000K/5700K		200lm/300lm - CRI 80	5/7	200lm/300lm - CRI 80
			112536-00		4000K/5700K		400lm - CRI 80	7	400lm - CRI 80

623 Safety 3.0 AUTOTEST CCT - EM +h S.E. Emergency Only - S.A. Maintained

		CLD CEM-L (AUTOTEST)		CCT SWITCH		LUMEN OUTPUT S.E. (tq= 25 °C)		LUMEN OUTPUT S.A. (tq= 25 °C)	
LED	colour	weight	code	autonomy	Kelvin	W tot S.E.	K - ølm - CRI	W tot S.A.	K - ølm - CRI
LED	white	0.50	112563-00	3h	4000K/5700K	1	70lm/110lm/150lm - CRI 80	2/3/4	70lm/110lm/150lm - CRI 80
			112564-00		4000K/5700K		200lm/300lm - CRI 80	5/7	200lm/300lm - CRI 80
			112566-00		4000K/5700K		400lm - CRI 80	7	400lm - CRI 80

EM S.E. (Only EMERGENCY):

during of a blackout, the luminaire connected to the emergency circuit will switch on, preventing any inconvenience caused by the sudden loss of lighting. It offers an autonomy of 60/180 minutes. The battery automatically recharges once the power is restored.

EM S.A. (Maintained):

during a blackout, the luminaire connected to the emergency circuit stays on, preventing any inconvenience caused by the sudden loss of lighting. It offers an autonomy of 60/180 minutes. The battery automatically recharges once the power is restored.

Safety with AUTOTEST:

provides real-time information on the status of the luminaire, automatically performing all the tests indicated in the UNI-EN-50172 standard. A simple way to reduce costs and make system inspection and maintenance easier. Anyone can supervise the emergency lighting system.

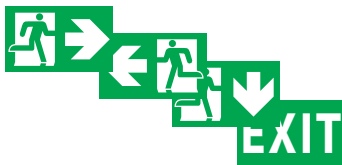

acc. 472 labels for Safety 2.0

right out	995137-00
left out	995138-00
down out	995139-00
exit	995144-00

Self-adhesive pictograms available and visible up to 35 m. UNI EN1838.



acc. 315 outer shell

white	995212-00
-------	-----------

Made in polycarbonate. For recessed installation of Safety 2.0.

visible up to 22 m. UNI EN1838

Safety 3.0 provides real-time information on the status of the luminaire, performing all the tests indicated in the UNI-EN-50172 standard. A simple way to reduce costs and make system inspection and maintenance easier. Anyone can supervise the emergency lighting system.

Safety 3.0 with AUTOTEST

OPERATION	DESCRIPTION
After 1st installation (power keep on during 24hrs).	At the beginning of the test a red LED indicator will flash slowly for 15 seconds, then the unit will switch to emergency mode for 3hrs and switch back to normal operation.
Functional test - 5 min (every 30 days).	Green LED indicator will flash slowly (1sec on / 1sec off).
Full duration test - 3 hrs (every 180 days).	At the beginning of the test a red LED indicator will flash slowly for 15 seconds, then the unit will switch to emergency mode for 3 hrs and switch back to normal operation. If full charge, green LED indicator will flash slowly (1sec on / 1sec off).
Emergency Mode: when voltage drop to 152-165V, the unit switch to emergency mode automatically.	LED indicator si off.

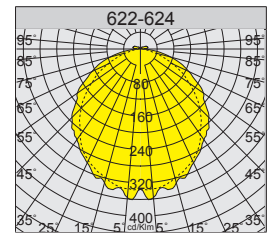
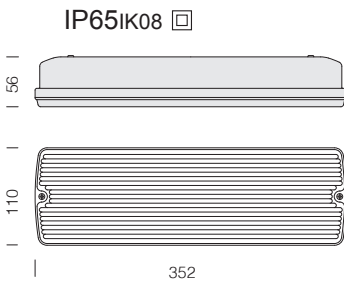

- RG0
- U.V.
- IP65
- +35°C to +5°C
- 4000K to 5700K

Upon request: fixtures with **sub-code -95** with an emergency system featuring the standard DALI protocol (inverter only), compatible with all advanced centralised control systems.

NOTE: the **-95** equipped product will remain **ON-OFF** and not DALI dimmable (order with subcode **-9541**).

624 Safety 2.0 - DALI - EM 1h S.E. Emergency Only

		CLD ED		CCT SWITCH		LUMEN OUTPUT S.E. (tq= 25 °C)	
LED	colour	weight	code	autonomy	Kelvin	W tot S.E.	K - ølm - CRI
LED	white	1.00	112534-95001025	1h	4000K/5700K	1	750lm - CRI 80



EM S.E. (Only EMergency):

during of a blackout, the luminaire connected to the emergency circuit will switch on, preventing any inconvenience caused by the sudden loss of lighting. It offers an autonomy of 60/180 minutes. The battery automatically recharges once the power is restored.

622 Safety 2.0 - DALI - EM 1h S.A. Maintained

		CLD ED		CCT SWITCH		LUMEN OUTPUT S.E. (tq= 25 °C)		
LED	colour	weight	code	autonomy	Kelvin	W tot S.A.	K - ølm - CRI	% EM operation
LED	white	1.00	112544-95001026	1h	4000K/5700K	7	850lm - CRI 80	88%



EM S.A. (Maintained):

during a blackout, the luminaire connected to the emergency circuit stays on, preventing any inconvenience caused by the sudden loss of lighting. It offers an autonomy of 60/180 minutes. The battery automatically recharges once the power is restored.



acc. 472 labels for Safety 2.0

right out	995137-00
left out	995138-00
down out	995139-00
exit	995144-00

EM self-adhesive pictograms.

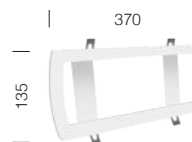

acc. 315 outer shell for Safety 2.0

white	995212-00
-------	-----------

Made in polycarbonate. For recessed installation of Safety 2.0.

visible up to 22 m. UNI EN1838



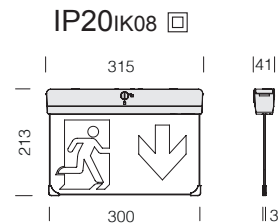
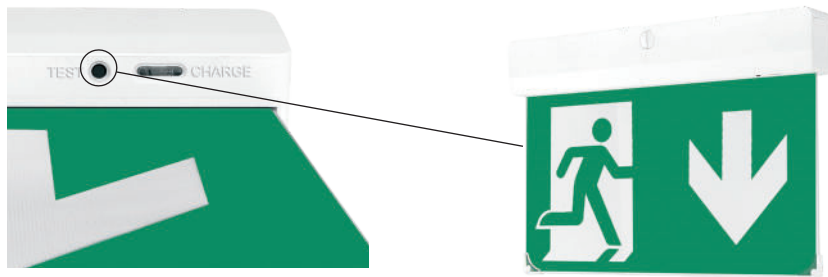
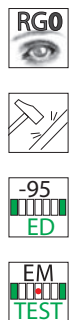

S.A. Emergency (Maintained): in the event of a black-out the one lamp connected to the back-up circuit stays on, thus avoiding the inconvenience caused by a sudden absence of all light. Emergency run time: 180 minutes. When power is restored, the battery recharges automatically.

Upon request: fixtures with **sub-code -95** are available with an emergency system featuring the standard DALI protocol (inverter only), compatible with all advanced centralised control systems.

NOTE: the -95 equipped product will remain ON-OFF and not DALI dimmable (order with subcode -9541).

630 Safety Flag - EM 3h S.A. Maintained



		CLD CEM-L					LUMEN OUTPUT (tq= 25 °C)	
LED	colour	weight	code	autonomy	W tot	K - ølm - CRI		
LED	white	0.50	112521-00	3h	3	6500K - 320lm - CRI 80		

EM power: 1W max. DALI 2 version available on request.

EM S.A. (Maintained):

during a blackout, the luminaire connected to the emergency circuit stays on, preventing any inconvenience caused by the sudden loss of lighting. It offers an autonomy of 60/180 minutes. The battery automatically recharges once the power is restored.



acc. 485 flag-type bracket

995440-00

To be used for flag installation of Safety Flag.



acc. 486 recessed frame

995441-00

To be used for recessed installation of Safety Flag.



acc. 487 suspension bracket

995442-00

To be used for suspension installation of Safety Flag.

Safety Flag is suitable for flag-type, recessed, and pendant installation using the supplied accessories. Installation is simple, quick, and safe, while the different configurations provide maximum versatility, adapting to all application needs.

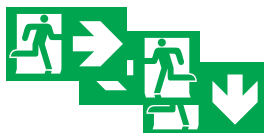

acc. 470 labels for art. 630

right out	995150-00
left out	995151-00
down out	995152-00

Pictograms available and visible up to 40 m. UNI EN1838. Bag containing 2 pieces

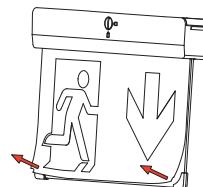

EM Label designed to be quickly and easily detached from the fixture.

The **Safety** series provides real-time information on the status of the luminaire, performing all the tests indicated in the UNI-EN-50172 standard. A simple way to reduce costs and make system inspection and maintenance easier. Anyone can supervise the emergency lighting system.

Safety Round - Safety Square - Safety Flag with MANUALTEST button			
OPERATION	TEST	ACTION	DESCRIPTION
Manual functional test	Press the test button	Simulates emergency duration of 3 seconds	Indicator flashes rapidly (0.5 s on / 0.5 s off)
Monthly test	Press the test button twice within 2 seconds	Simulates emergency duration of 60 seconds	Indicator flashes rapidly (0.5 s on / 0.5 s off)
Annual test	Press the test button 3 times within 2 seconds after a continuous 24-hour recharge	Simulates emergency duration of 3 hours	Indicator flashes rapidly (0.5 s on / 0.5 s off)
Reset	Press and hold the test button for more than 3 s (Safety Round/Square) or 10 s (Safety Flag)	Resets the self-test programme	Indicator flashes 3 times (0.5 s on / 0.5 s off)
Troubleshooting	Press and hold the test button for more than 5 s	Elimination of errors	Indicator flashes 3 times (0.5 s on / 0.5 s off)

IP65IK08

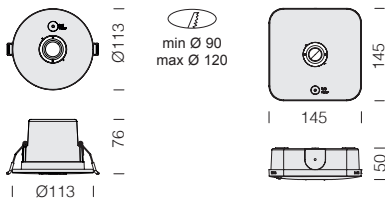

Upon request: fixtures with **sub-code -95** are available with an emergency system featuring the standard DALI protocol (inverter only), compatible with all advanced centralised control systems.

NOTE: the -95 equipped product will remain ON-OFF and not DALI dimmable (order with subcode -9541).

EM S.E. (Only Emergency):

during of a blackout, the luminaire connected to the emergency circuit will switch on, preventing any inconvenience caused by the sudden loss of lighting. It offers an autonomy of 60/180 minutes. The battery automatically recharges once the power is restored.

629 Safety Round - EM 3h S.E. Emergency Only - recessed

		CLD CEM-L				LUMEN OUTPUT (tq= 25 °C)	
LED	colour	weight	code	autonomy	W tot	K - ølm - CRI	
LED	white	0.20	112500-00	3h	3	6500K - 320lm - CRI 80	
EM power: 2,2W max.							



628 Safety Square - EM 3h S.E. Emergency Only - ceiling

		CLD CEM-L				LUMEN OUTPUT (tq= 25 °C)	
LED	colour	weight	code	autonomy	W tot	K - ølm - CRI	
LED	white	0.30	112509-00	3h	3	6500K - 320lm - CRI 80	
EM power: 2,2W max.							

The luminaire comes with easily interchangeable optic, specifically designed for:

- anti-panic lighting in large areas: standard round lens.
- corridor/escape route lighting: optional oval lens.

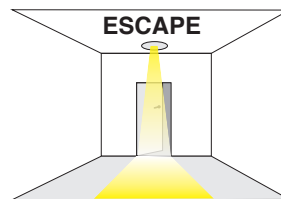
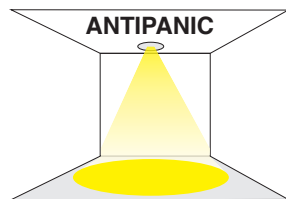

S.E. Emergency (Emergency only): in the event of a black-out the one lamp connected to the back-up circuit ignites, thus avoiding the inconvenience caused by a sudden absence of all light. Emergency run time: 180 minutes. When power is restored, the battery recharges automatically.



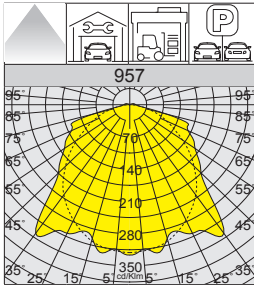

IP66IK08

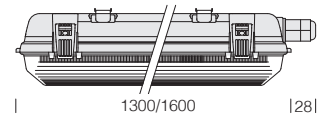
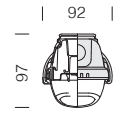

957 Echo HE - EM 1h - single LED module



		CLD E			LUMEN OUTPUT (tq= 25 °C)		% EM operation	
LED	colour	weight	L	code	W tot	K - ølm - CRI	h	%
LED	grey	2.10	1300	164730-07	42	4000K - 6543lm - CRI>80	1h	9%
		2.40	1600	164736-07	54	4000K - 8343lm - CRI>80	1h	7%

957 Echo HE - EM ED 1h - single LED module



		CLD ED			LUMEN OUTPUT (tq= 25 °C)		% EM operation	
LED	colour	weight	L	code	W tot	K - ølm - CRI	h	%
LED	grey	2.10	1300	164730-95	42	4000K - 6543lm - CRI>80	1h	9%
		2.40	1600	164736-95	54	4000K - 8343lm - CRI>80	1h	7%

957 Echo HE - EM AD 1h - single LED module



		CLD - Self-diagnosis			LUMEN OUTPUT (tq= 25 °C)		% EM operation	
LED	colour	weight	L	code	W tot	K - ølm - CRI	h	%
LED	grey	2.10	1300	164730-0766	42	4000K - 6543lm - CRI>80	1h	9%
		2.40	1600	164736-0766	54	4000K - 8343lm - CRI>80	1h	7%

957 Echo HE - EM EC - single LED module



		CLD EC			LUMEN OUTPUT (tq= 25 °C)	
LED	colour	weight	L	code	W tot	K - ølm - CRI
LED	grey	1.60	1300	164730-0050	39	4000K - 6543lm - CRI>80
		1.90	1600	164736-0050	51	4000K - 8343lm - CRI>80

EM EC: with emergency wiring supplied by centralised power unit: permanent luminaire, with power supply unit operating in AC/DC, powered by a central emergency unit (NOT incorporated into the luminaire).

Echo

Housing: injection moulded, vandal resistant, UV stabilised RAL 7035 grey polycarbonate, high mechanical resistance thanks to the stiffening ribs inside the structure.

Diffuser: injection moulded V2 self-extinguishing, UV stabilised clear polycarbonate, prismatic inside for better light control. The smooth outside finishing facilitates cleaning, essential to ensure maximum lighting efficiency at all times.

Reflector: in galvanised steel, previously stove-enamelled with UV-stabilised polyester resin.

Equipment: plug connector. Material compatible with food industry environments. Mounting is also possible at low or very low temperatures (instant start and no flux decay).

For applications with direct exposure to sunlight, we recommend using Forma LED. Check the compatibility between the material constituting the product and the space where it will be installed.

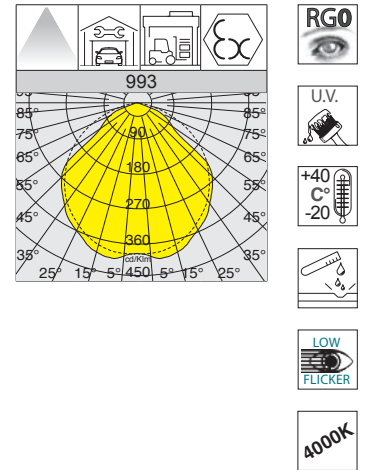
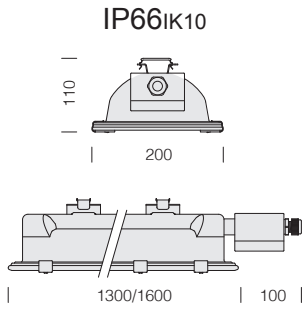

993 Forma ATEX - EM EC - with transparent glass

EM EC: with emergency wiring supplied by centralised power unit: permanent luminaire, with power supply unit operating in AC/DC, powered by a central emergency unit (NOT incorporated into the luminaire).

LED	colour	CLD EC			W tot	LUMEN OUTPUT (tq= 25 °C)	
		weight	L	v		K - ølm - CRI	
LED	grey	7.20	1293	162495-0050	45	4000K - 6000lm - CRI>80	
		9.20	1593	162496-0050	65	4000K - 9264lm - CRI>80	

-0050
EM-EC

993 ATEX	
Protection against explosions	II 3G Ex nA OP IS IIC T4 IP65 Gc II 3D Ex tc IIIC T135°C IP65 Dc
Allowed dangerous area	Zone 2; Zone 22
Allowed room temperature	-20°C ÷ +40°C
Degree of protection	IP65
Installation	ceiling - suspension
Casing mechanical resistance	IK08
Reference regulations	EN 60079-0; EN 60079-15; EN 60079-31; EN 60079-28

Forma ATEX

Housing: made of pressed steel, drawn in a single piece for high mechanical resistance. Supplied with frame.

Diffuser: impact-resistant transparent tempered glass.

Coating: the standard powder coating consists of a first metal surface pre-treatment stage and of single layer of UV-stabilised, corrosion and salt resistant polyester powder coating.

Standard supply: silicone rubber gasket. M20 nickel-plated brass cable gland. Locking system in stainless steel.



Astro Q

Housing/Frame: in die-cast aluminium with cooling fins integrated into the cover and designed with a very small surface exposed to wind.

Lenses: in PMMA, highly resistant to temperature and UV radiation.

Diffuser: art. 2900-2901-2902 with tempered glass, 4 mm thick, resistant to thermal shocks and impacts (UNI-EN 12150-1: 2001).

Coating: the standard powder coating consists of a first metal surface pre-treatment stage and of single layer of UV-stabilised, corrosion and salt resistant polyester powder coating.

Standard supply: the fixture is equipped with air recirculation valve and insulation connector for quick installation with **no need to open the fixture**; silicone rubber gasket; external screws and bolts in stainless steel. temperature control inside the device with automatic resetting.

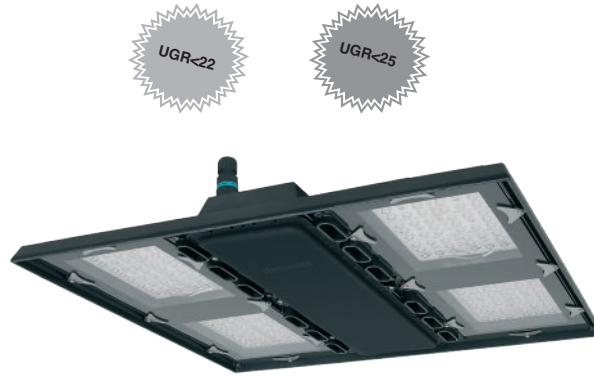
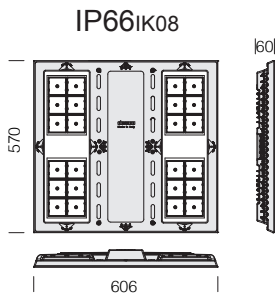

200W+350W
=6/6kV
SURGE

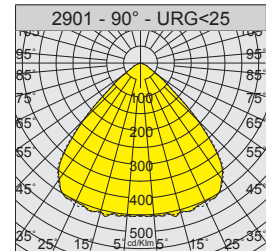
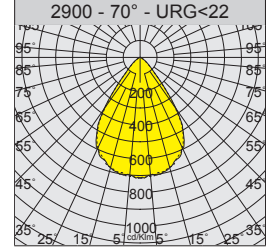

2900 Astro Q1 - EM EC - UGR<22 - 70°

LED	colour	weight	CLD EC		LUMEN OUTPUT (tq= 25 °C)	
			code	W tot	K - ølm - CRI	
LED	RAL 7021	10.50	380000-0050	200	4000K - 35343lm - CRI 80	
			380001-0050	250	4000K - 42620lm - CRI 80	
			380002-0050	300	4000K - 50936lm - CRI 80	
			380003-0050	350	4000K - 57173lm - CRI 80	



2901 Astro Q1 - EM EC - UGR<25 - 90°

LED	colour	weight	CLD EC		LUMEN OUTPUT (tq= 25 °C)	
			code	W tot	K - ølm - CRI	
LED	RAL 7021	10.50	380010-0050	200	4000K - 35700lm - CRI 80	
			380011-0050	250	4000K - 43050lm - CRI 80	
			380012-0050	300	4000K - 51450lm - CRI 80	
			380013-0050	350	4000K - 57750lm - CRI 80	



EM EC: with emergency wiring supplied by centralised power unit: permanent luminaire, with power supply unit operating in AC/DC, powered by a central emergency unit (NOT incorporated into the luminaire).

Note: the standard version operates at 100% of its luminous flux (lm).

Upon request: rates of luminous flux (lm) can be customised but with a minimum level of 15%.



RECOMMENDED INSTALLATIONS:

- environments with very high ceilings (warehouses, distribution centres, hubs, etc.)
- environments where maintenance may be difficult (indoor swimming pools)
- large or multi-storey facilities where remote control is preferred (offices, hospitals, public places)



MAINTENANCE DOES NOT REQUIRE THE USE OF SPECIAL MACHINERY

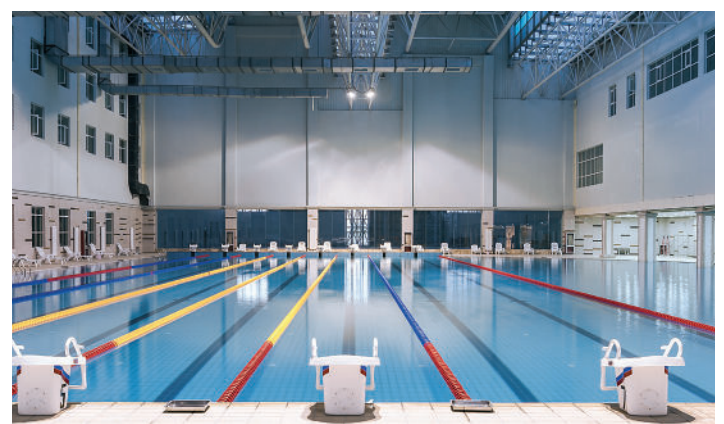

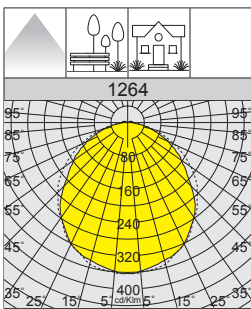

Self adhesive pictograms available:

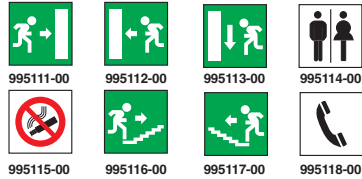

IP65IK08

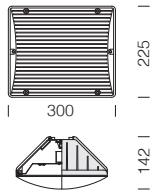

1264 Vega - EM 1h



		CLD E		LUMEN OUTPUT (tq= 25 °C)		% EM operation	
LED	colour	weight	code	W tot	K - ølm - CRI	h	%
LED	black	2.00	420665-07	10	4000K - 1760lm - CRI 70	1h	31%
	grey		420666-07				

Vega

Housing: in nylon UV-stabilised.

Reflector: hammered aluminium.

Diffuser: anti-glare, vandal resistant, V2 selfExtinguishing, UV-stabilised matt polycarbonate.

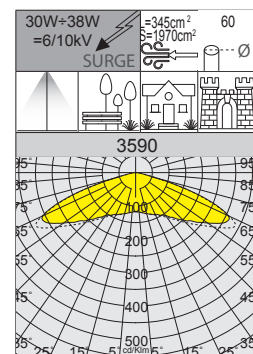
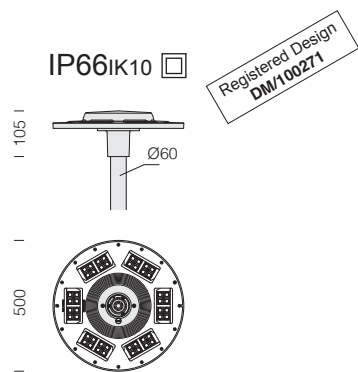

3590 Ischia - EM 1h - rotsymmetric wide beam RW

LED	colour	weight	CLD E		LUMEN OUTPUT (tq= 25 °C)		% EM operation	
			code	W tot	K - ølm - CRI	h	%	
LED	graphite	5.40	424660-07	30	4000K - 4770lm - CRI 70	1h	13%	
			424660-0728		3000K - 4510lm - CRI 70			
LED	graphite	5.40	424661-07	38	4000K - 6030lm - CRI 70	1h	10%	
			424661-0728		3000K - 5710lm - CRI 70			



Ischia

Housing: pressed in die-cast aluminium.

Pole connection: pressed in die-cast aluminium. Suited for poles with a diameter 60 mm.

Diffuser: polycarbonate 2,5 mm thick, thermal shock and impact resistant (UNI-EN 12150-1: 2001).

Coating: the standard powder coating consists of a first metal surface pre-treatment stage and of single layer of UV-stabilised, corrosion and salt resistant polyester powder coating.

Upon request: coating for marine environments (seafrent) in compliance with UNI EN ISO 9227.

EMERGENCY

SELECTION OF EM LIGHTING

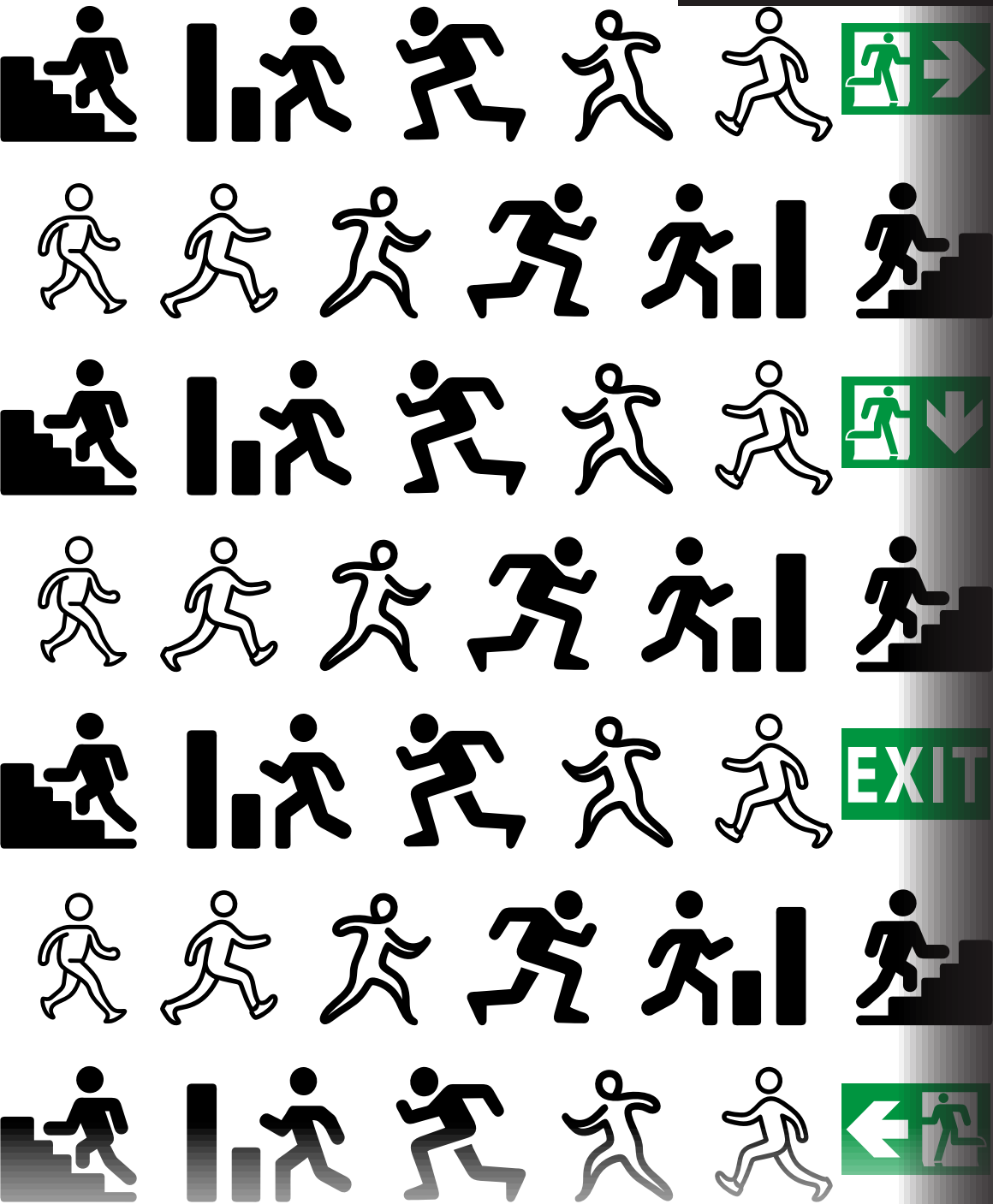

disano 
illuminazione

Disano illuminazione S.p.A.
Viale Lombardia, 129
20089 Rozzano - Milano
centralino: 02 82 47 71
email: info@disano.it
customerservice@disano.it
web: www.disano.it

fosnova

FOS NOVA s.r.l.
Via Como, 9
20089 Rozzano - Milano
centralino: 02 82 47 71
email: info@fosnova.it
customerservice@disano.it
web: www.fosnova.it

